

# Ultrasonic heat and cooling energy meters

UH50..



### Ultrasonic heat and cooling energy meters to measure flow and energy in hydronic heating or refrigerant circuits.

- Available as heat, cooling energy, or combined heat/cooling energy meters
- Separate acquisition of heat or cooling energy by the combined heat/cooling energy meters, with automatic changeover
- Non-wearing due to non-moving parts
- Approved in accordance with EN 1434 and MID accuracy class 2
- Any mounting position (horizontal or vertical), in return
- Measuring range of flow 1:100 as per EN 1434, 1:1,000 total range
- Choice of various communication modules and power supplies
- Upstream or downstream setting paths are not required
- Optical interface as per EN 62056-21
- Self diagnostics

## Application

The UH50.. heat and cooling energy meter physically acquires energy consumption. The amount of heat or cooling energy is acquired separately and can be read out either on site or from a remote location. The device consists of a flow measuring section and processor unit. The processor unit can be equipped with different sensors, different types of power supply and communication modules. The UH50.. measures the consumption of heat in district heating systems and blocks of flats. It is also suited to measure the consumption of cooling energy (cooling energy only or in combination with thermal energy), or volume flow in hydronic systems.

### Restrictions

Do not use the UH50.. to measure potable water.

Also, the product is not suited for use in systems operating on water-glycol mixtures.

## Functions

### Ultrasonic measuring principle

The flow is acquired based on the non-wear ultrasonic measuring principle, which requires no moving parts.

The quantity of energy supplied to the consumer by the medium during a certain period of time is proportional to the temperature differential of flow and return and the volume flow passing through the meter.

The **water volume** is measured in the measuring tube by ultrasonic pulses which are transmitted in the direction of flow and against the direction of flow. Downstream, the time required by the pulses to travel from the transmitter to the receiver is reduced, upstream it is increased. The water volume is calculated based on the difference in runtime.

The **flow and return temperatures** are determined using platinum resistors.

The water volume as well as the temperature difference between the warmer and cooler side is multiplied using a heat coefficient and the product is integrated. The result, which is the consumed **heating or cooling energy quantity**, is registered and displayed in the physical **units kWh/MWh or MJ/GJ**; the volume in **m<sup>3</sup>**.

### Processor unit

The electronics unit includes a built-in service unit. A common electronic unit applies to all flow variables.

### Optical communication interface

The meter is supplied with an optical close-range interface. The meter is equipped with an optical communication interface which facilitates readout and configuration on site with the help of the optical read head WZR-OP-USP and matching UltraAssist software.

### Self diagnostics

The meter continuously performs self-diagnostics, allowing it to detect a number of mounting or device errors and to display them.

**Metering accuracy as per EN 1434**

The diagram below shows the typical metering accuracy of the UH50., compared to the error limits per EN 1434, class 2.

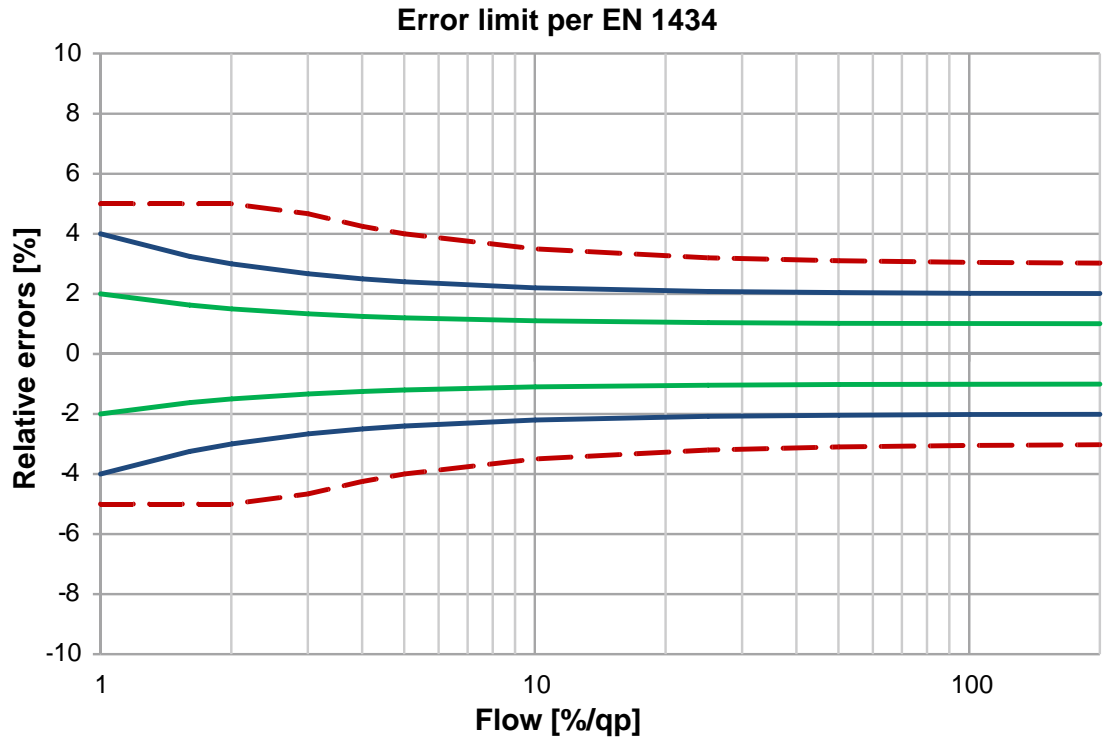

Key:

- - - EN 1434, class 3
- EN 1434, class 2
- UH50.. typical (EN 1434, ½ class 2)

q Current flow that determines the precision as a percentage of the continuous flow qp

qi Lower flow limit (value 1 on the x axis = 1 % of qp):  
The smallest flow above which the heat meter must operate without exceeding the fault limits.

qp Continuous flow of meter = Value 100 on the x axis.

The pressure loss in a flow sensor is indicated as continuous flow qp.

Actual pressure loss at the indicated flow can be calculated using the Kv value, which indicates flow at 1 bar differential pressure:

$$\Delta p = 1 \text{ bar} \times \left(\frac{Q}{K_v}\right)^2$$

$\Delta p$  = Pressure loss in bar

Q = Flow in m<sup>3</sup> / h

Kv = Kv – Value at  $\Delta p = 1$  bar

Continuous flow $q_p$ m <sup>3</sup> /h	Mounting length mm	Connecting thread	Pressure loss at $q_p$ mbar	Kv value at $\Delta p = 1$ bar m <sup>3</sup> /h	Curve in the diagram
0.6	110, 190	G ¾, G 1, DN20	150	1.5	A
1.5	130, 190	G 1, DN20	160	3.8	B
1.5	110	G ¾	150	3.9	C
2.5	190	G 1, DN20	210	5.3	D
2.5	130	G 1	200	5.6	E
3.5	260	G 1¼, DN25	55	15	F
6	150	G 1¼	190	14	G
6	260	G 1¼, DN25	140	16	H
10	200, 300	G 2, DN40	130	28	I
10	300	G 2	110	30	J
15	270	DN50	110	45	K
15	200	DN50	95	49	L
25	300	DN65	105	77	M
40	300	DN80	160	100	N
60	360	DN100	115	177	O
150	500	DN150	120	433	P

The value can also be read graphically using the diagram as an alternative.

#### Pressure drop characteristic

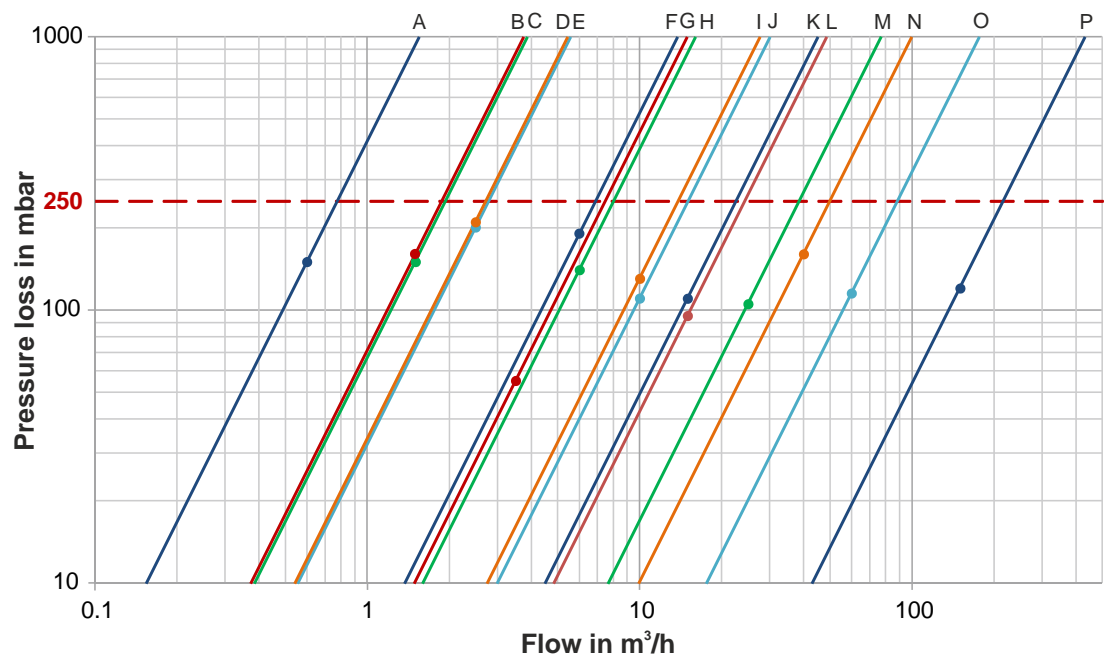

## Display

The meter displays current readings in kWh, MWh, MJ or GJ.

You can only select between kWh or MWh and MJ or GJ on the meter.

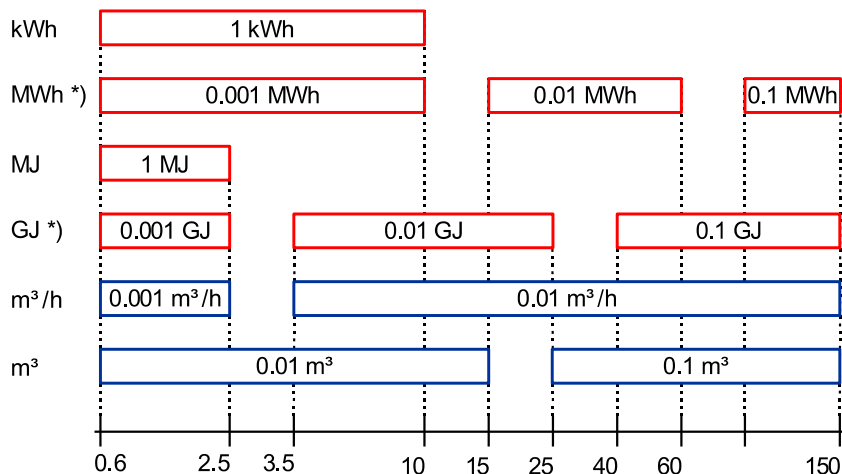

\*) Decimal places "flashing", "static", or "suppressed"

The decimal places of displayed values are outlined to avoid errors.

Calibrated values are identified by a star symbol.

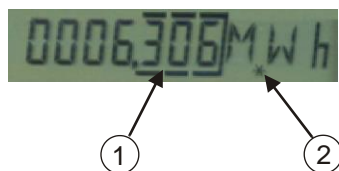

- 1 Decimal places outlined      2 Calibrated value

The number of decimal places of a value depends on the selected measuring path and the selected unit.

The meter's displays are arranged in 5 loops:

- 1 user loop
- 4 service loops

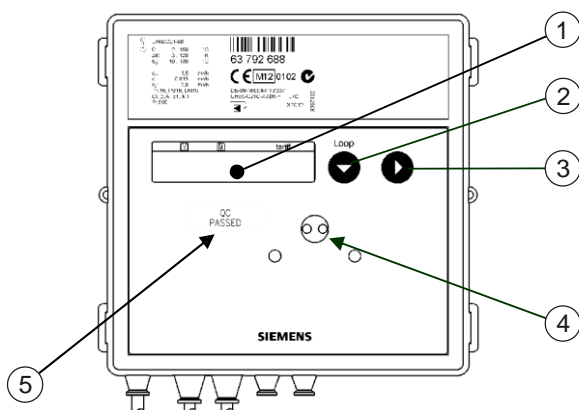

- 1 Display      2 Button 1  
 3 Button 2      4 Optical interface  
 5 Calibration seal

A short press on button 1 enables selection of the required loop. The user loop reappears after the last loop. Press button 2 to read the value on the respective loop. The first value reappears after the last loop.



The range of display and the displayed data may deviate from this description and certain button functions may be disabled, depending on the parameter settings on the meter.

### User loop

#### LOOP 0

	Error message with error code number (only in case of error)
	Accumulated energy with tariff state
	Tariff register 1 (optional)
	Accumulated volume
	Segment test

### Service loop

#### LOOP 1

	Current flow rate
	Current power
	TF: Current temperature on the heat side
	TR: Current temperature on the cold side; at 2-second intervals
	Operating time
	Operating time with flow rate
	Error time
	Property number, 8 digits
	Date
	Yearly set day (DD.MM)
	Energy for previous year on set day
	Volume for previous year on set day
	Firmware version

### Service loop

#### LOOP 2

	Measuring period for maximum calculation
--	--

## Service loop

### LOOP 3

	Monthly value (set day)
	Energy on set day
	Tariff register 1 on set day
	Volume on set day
	Max. flow rate on set day, at 2-second intervals with date stamp
	Max. power on set day, <sup>[1]</sup> at 2-second intervals with date stamp
 	Max. temperatures on set day, at 2-second intervals with data stamp, for temperature heat or cold side
	Missing time count on set day



Changing the number of months to be read via the service software impacts the number of months that can be called up via the LCD.

## Service loop

### LOOP 4

 	Current tariff, at 2-second intervals with threshold value 1
	Measuring interval for flow rate
	Measuring interval for temperature
	Module 1: M-bus module
	M-bus primary address 1
	M-bus secondary address 8-digit
 	Module 2: Pulse module; channel 1 = Energy, Channel 2 = Volume; at 2-second intervals
	Valency for energy pulses *)
	Valency for volume pulses *)
	Pulse duration in ms *)

\*) For "fast pulses"

### Previous year's values

The electronic unit stores the meter readings for energy, volume, tariff register, missing time, and flow measuring time as well as the current maximum values of flow rate, power, temperature differential, temperature heat and cold side with their date stamps on a yearly set day.

## Monthly values

The processor unit stores the meter readings for energy, volume, the tariff register, missing time, and flow rate measuring time as well as the monthly maximums for flow rate, power, temperature differential, temperature heat and cold side with their date stamp for up to **60 months** on the set day of each month.



Central European Time (CET) is the default time. Storage is performed at the appropriate times if daylight saving time is activated.

Previous year's values and monthly values can also be read out via the optical and the 20-mA interface.

## Error codes

The meter continuously performs self-diagnostics, allowing it to detect a number of mounting or device errors and to display them.

Error code	Error	Notes on service
FL nEG	Wrong direction of flow	Check flow or installation direction; correct if necessary
<b>If necessary, alternating with:</b>		
DIFF nEG	Negative temperature differential	Check place of installation of sensors; replace as required
<b>If necessary, alternating with:</b>		
F0	Flow cannot be measured	Air in the measuring section/pipe; vent the pipe (as supplied)
F1	Interruption in temperature sensor heat side	Check sensors, replace as needed
F2	Interruption in temperature sensor cold side	Check sensors, replace as needed
F3	Electronics for temperature assessment defective	Replace meter
F4	Battery exhausted; problem in connection with power supply	Replace battery; Check connection
F5	Short circuit in temperature sensor heat side	Check sensor; replace as required
F6	Short circuit in temperature sensor cold side	Check sensors, replace as needed



Error code	Error	Notes on service
F7	Fault in the internal memory	Replace meter
F8	Errors F1, F2, F3, F5, or F6 pending for more than 8 hours, detection of tampering attempts. No further measurements are made	Action is based on the error code. Service must reset error message F8
F9	Error in the electronics	Replace meter

### Standard parameters

It is programmed at the factory as follows:

- Set day [TT.MM]: 01.01



### Power supply

The UH50.. can be powered by a power supply or battery.



### Automatic mains detection

The power supply detects whether line voltage is present. The signal is provided to the UH50... The device automatically detects whether it is powered by a battery or a power supply.

### Power packs

	
<p>Power pack AC/DC 24 V WZU-ACDC24-50</p>	<p>Power pack AC 110/230 V WZU-AC110/230-15 WZU-AC110/230-50</p>

## Batteries

	
Standard battery (2 AA) WZU-BA+GUM	Universal battery (D-cell) WZU-BDS
	
Battery with compartment for NB-IoT module	

## Battery life

Battery life depends on the type of battery and requirements (e.g. short time base, analog module, etc.).

<b>NOTICE</b>	
<b>!</b>	Install only batteries approved by the manufacturer.

Requirements (with time base Q = 4 s and T = 30 s)	6 years	11 years	16 years	Power section AC 110/230 V; AC / DC 24 V
<b>Pulse module</b> (standard pulses) <b>M-bus module G4</b> (Normal read mode 15 min.) <b>BACnet/Modbus module</b> (Read > 10 min.)	2x AA cell	C	D	Yes
<b>RF module 868 MHz</b> (stationary 15 min. transmission interval)	D	D	D	Yes
<b>RF module 868 MHz</b> (mobile 16 sec. transmission interval)	D	D	-	Yes
<b>RF module LoRaWAN</b> *) In Eco mode Transmission interval for 11 year life cycle: 60 min. Transmission interval for 16 year life cycle: 160 min. **) Restrictions, see Module user's guide	-	D *)	D *)	Yes **)

<b>RF module NB-IoT-G2, band 3, 8, 20</b> ***) and auxiliary battery for NB-IoT (WZU-NB-IoT-BAT)	-	C ***)	-	Yes
<b>GPRS module</b>	-	-	-	Yes
<b>M-bus module G4</b> (Fast read mode 4 sec.) <b>Pulse module</b> (Fast pulses) <b>Analog module</b> <b>BACnet/Modbus module</b> (Read < 10 min.)	D	-	-	Yes
<b>Fast time base</b> (with time base $\frac{Q}{SEP} = 4 \text{ s}$ and $T = 4 \text{ s}$ )	D	-	-	Yes

The following table displays the **modules** requiring an external power supply.

Module	Type of power supply
BACnet/Modbus module	AC/DC 24 V, e.g. WZU-NE24
Analog module	AC/DC 24 V, e.g. WZU-NE24

## Communication

### Communication module

The communication modules are connected via a 6-pole reaction-free plug, enabling them to be installed or replaced at any time.

**Compliance with ESD regulations must be ensured.**

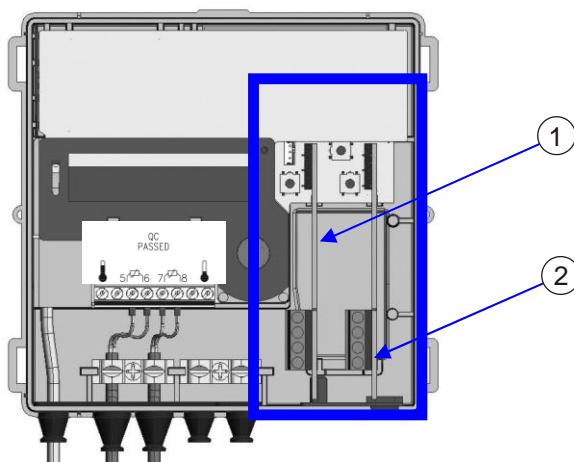

1 Module 1 2 Module 2

The UH50.. meters are equipped with an optical interface as standard. Also, up to 2 of the following communication modules can be used for remote readout:

Pulse module	WZU-P2
M-bus module	WZU-MB G4
M-bus module with 2 pulse inputs	WZU-MI
Analog module	WZU-AM
BACnet/Modbus module	WZU-485E-BAC, WZU-485E-MOD
RF module, 868 MHz	WZU-RF, WZU-RF-EXT
GPRS module	WZU-GPRS, WZU-GPRS-ANT
LoRaWAN module	WZU-LR, WZU-LR-EXT
NB-IoT module	WZU-NB-IoT-G2

These modules have no impact on consumption metering and can therefore be replaced at any time **without having to destroy the security seal**.

Within 30 seconds after mounting (in case of the analog module up to 2 minutes), the meter automatically detects the module used and is then ready for communication or for delivering pulses.

The type of module used can be displayed within the service loop (loop 4) based on the display parameters.

#### Permissible module combinations

AM	Analog module	Step 1: Slot for module 2 is equipped with...							
MB G4	M-bus module								
MB MI	M-bus module								
RF	RF module								
LoRa	LoRaWAN module								
BACnet	BACnet module								
Modbus	Modbus module								
NB-IoT	NB-IoT module								
GPRS	GPRS module								
		AM (3)	Pulse module		MB G4	GPRS	RF	LoRa	NB-IoT
			"Standard"	"Fast" (1)					
Step 2: Slot for module #1 can be equipped with...	AM	Yes	Yes	Yes	Yes	No	Yes	Yes	No
	Pulse module (2) "Standard"	Yes	Yes	Yes	Yes	Yes	Yes	Yes	Yes
	MB G4	Yes	Yes	Yes	Yes	Yes	Yes	Yes	Yes
	MB MI	Yes	Yes	Yes	Yes	No	Yes	Yes	No
	BACnet	No	No	No	Yes (4)	No	No	No	No
	Modbus	No	No	No	Yes (4)	No	No	No	No

### Restrictions:

\* Only 1 module with fast pulses is possible; and only permissible in slot 2;

min. pulse duration:

- 2 ms, if pulse module 1 is not fitted
- 5 ms, if pulse module 1 is fitted

\*\*) Subsequent mounting of a further pulse module in module slot 1 can result in changed output values for module 2!

(1) Pulse length of the fast pulses min. 5 ms

(2) The first and second channel can be configured individually!

(3) Do not insert the analog module in slot 2 on meters powered by AC 110/230 V

(4) Scan interval < 10 minutes required D cell (6 years) or power supply.

### Connection terminals

Multipolar connection terminals are used to connect external cables to the modules.

Choice of connections:

- Solid or stranded wire 0.2...2.5 mm<sup>2</sup>
- Stranded wire with ferrule 0.25...1.5 mm<sup>2</sup>
- Cable sizes 26 – 14 AWG

Multiline connection (2 lines of same cross-section)

- Solid or stranded wire 0.2...0.75 mm<sup>2</sup>
- Stranded wire with ferrule without plastic sleeve 0.25...0.34 mm<sup>2</sup>
- Stranded wire with TWIN ferrule and plastic sleeve 0.5...0.75 mm<sup>2</sup>

Recommended screwdriver 0.6x3.5 mm

Tightening torque 0.4 Nm

The exterior diameter must be between 4 and 6 mm. All wiring must be able to be guided to the meter through the existing bushings. It may be convenient to connect the cables before the meter in a single multi-conductor cable on a split box.

Do not connect shielded cables on the meter side (connect to one end only).

**Pulse module  
WZU-P2**

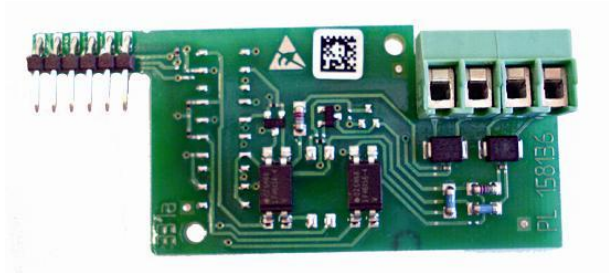

**Function description**

The pulse module WZU-P2 enables the meter to communicate with a pulse collector to transmit measured values. It outputs pulses that can be derived from the energy, volume, tariff register 1 or tariff register 2. Two channels are available; their function can be adapted using the service software.

The outputs are in the form of standard pulses or "fast pulses". The pulse duration is identical for channel 1 and channel 2.



The module can be plugged into either of the 2 slots. Fast pulses can only be supplied on slot 2.

**Standard pulses**

Standard pulse valencies

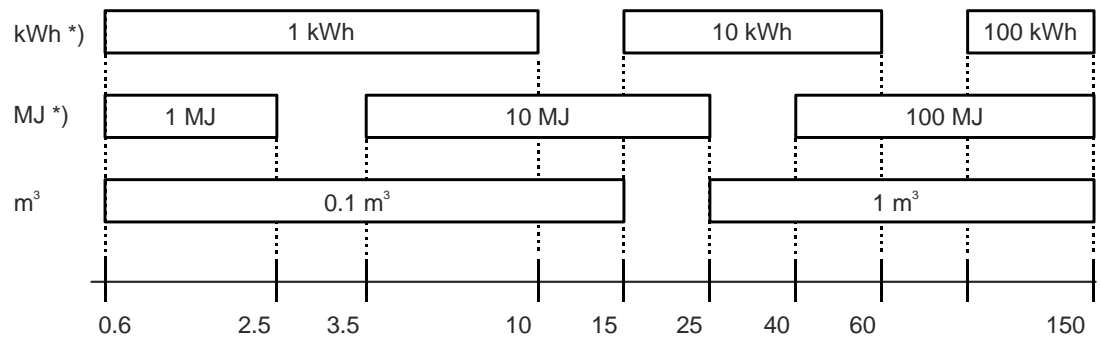

Continuous flow in m<sup>3</sup>/h

\*) depending on the unit for heat energy display

**Pulses for energy, volume, and tariff register**

Period duration >200 ms

Pulse duration: 100 ms conducting

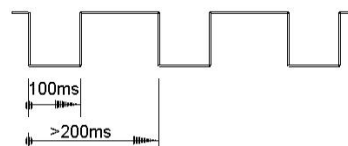

## Pulse for operating states

"Ready"	Pulsed "conducting", i.e. 0.1...0.25 ms pulse duration, 500 ms period
"Fault"	Constant "non-conducting"

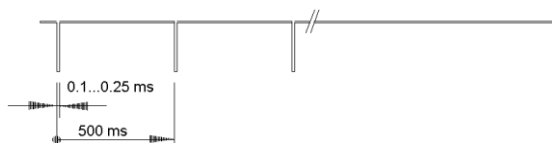

### Fast pulses

Applications, such as controllers or flow measuring sections, require higher pulse rates. The service software configures the parameters required for this purpose (pulse valency, pulse duration).

The maximum pulse frequency is 33 Hz.

## NOTICE



Use a D cell for battery operation.

The following can be set:

- Pulse type: "linear" or "scaled" pulses
- Pulse output: Energy or volume
- Pulse duration, if only 1 pulse module is fitted:
  - From 2 ms to 100 ms in increments of 1 ms
- Pulse duration, if 2 pulse modules are fitted:
  - From 5 ms to 100 ms in increments of 5 ms

A suitable device can be used to receive and evaluate the pulses. Enter the settings in accordance with the controller's data sheet.

Linear pulses are provided proportionally to the measured value. In the case of scaled pulses, the number of pulses at the upper and lower end of the range can be defined. In this case, the pulse receiving device can detect a wiring error, for example.

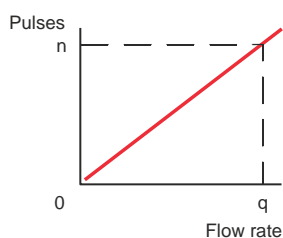

Linear pulses

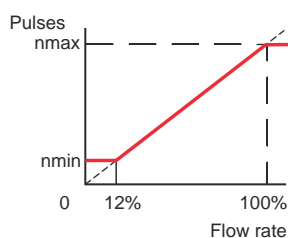

Scaled pulses

Display on LCD

Connection of outputs  
(standard version):

**CE, C2, CV, CT or RI**

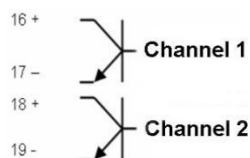

**M-bus module  
WZU-MB G4  
WZU-MI**



**Function description**

The M-bus modules (WZU-MB G4 and WZU-MI) are used by the meter to communicate with an M-bus central unit to transmit measured values.

With the 2 M-bus modules, the secondary address is identical for both modules. It can be adjusted on the device using the module on slot 1 or via M-bus.

The data on the M-bus module is refreshed every 15 minutes.

A shorter sampling cycle can be set using the UltraAssist software.

The modules are available in 2 different versions:

WZU-MB G4	<b>M-bus module</b> for heat and heat/cooling energy meters, generation 4, recommended as of firmware 5.15 per EN 13757 and EN 1434-3.
WZU-MI	<b>M-bus module with 2 pulse inputs</b> for heat and heat/cooling energy meters, generation 4, recommended as of firmware 5.15 per EN 13757 and EN 1434-3.



---

Module WZU-MB G4 can be used in both slots. Always plug module WZU-MI into slot 1.

---



## M-bus module with 2 pulse inputs WZU-MI



### Function description

In addition to the M-bus connection facility, the WZU-MI module has 2 pulse inputs to connect metering pulses from hot and cold water meters with Reed contact, relay or open collector. The cumulated volume is calculated based on the pulses and the set pulse valency, stored in the processor unit at 5-minute intervals and passed on via M-bus.



---

The volume values calculated by the meter from the pulse inputs cannot be officially calibrated.

---

In addition to possible power supply from the M-bus connection, the WZU-MI module is equipped with a battery. It powers the module processor and the pulse input, if no M-bus voltage is applied. Either isolated contacts (e.g. relay or Reed contacts) or electronic transmitters (open collectors) can be used as pulse transmitters for the pulse inputs. If an open collector circuit is used as the transmitter of the pulse inputs, the cable must always be electrically isolated from the M-bus inputs of the WZU-MI module.

## BACnet/Modbus module WZU-485E-BAC WZU-485E-MOD



The processor unit uses both modules to communicate over ModBus® or BACnet™. The ModBus® module is suitable (and preconfigured) for data transmission per the ModBus®-RTU protocol over RS485.

The BACnet™ module is suitable (and preconfigured) for data transmission per the BACnet™ protocol over RS485 and BACnet™ MS/TP.

## NOTICE



### Update internal memory

A value of 0 is returned if a data request arrives as the module is updated its internal memory.

- Set the data query to  $\geq 15$  s for data requests to the Modbus module (card).
- Set the data query to  $\geq 15$  s for broadcast command.

### Mechanical design

**WZU-485E-MOD** RTU communication over RS485, transmission rate up to 19200 baud, setting the transmission rate and parity of the software (USB, cable connection), refresh rate up to 10 sec. For UC50.. and for UH50.. as of firmware 5.15 and higher

**WZU-485E-BAC** MS/TP communication over RS485, transmission rate up to 76800 baud, setting the transmission rate and parity of the software (USB, cable connection), refresh rate up to 10 sec. For UC50.. and for UH50.. as of firmware 5.15 and higher

Both modules are externally powered with AC/DC 24 V and galvanically isolated from the processor unit.

Switch off the module power supply before connecting it to the PC using the USB cable.

The micro USB interface is used exclusively to configure the communication protocol and speed.

### Analog module

#### WZU-AM

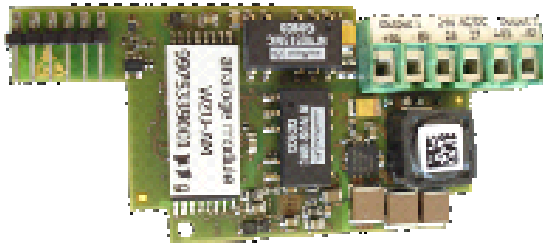

### Function description

The analog module (WZU-AM) converts the measured value from the meter to an analog signal. Each module has 2 channels with functions that can be configured independently. The service software configures the unit (selection of measured values and output ranges). The output signal is refreshed at 4-second intervals.



The analog module can be plugged into either of the 2 slots and 2 modules can be used concurrently.

### Power supply

The module must be powered via an external power pack (e.g. WZU-NE24). The 2 cables of the power pack are interchangeable. The 2 analog modules can be powered by the same power pack.

The module(s) and the meter can be connected to the same power outlet if the meter is mains-powered (AC/DC 24 V). In this case, the wires must be bridged on module WZU-AM; the plug-in terminals on the meter's power pack are not suited for that purpose.

If a meter is used with an analog module, a D-cell is required – if battery-powered.

### External fuse

Each analog module **must** have its own external fuse.

### RF module, 868 MHz WZU-RF, WZU-RF-EXT



### Function description

The RF modules (WZU-RF and WZU-RF-EXT) enable the meter to communicate wirelessly with a control unit at 868 MHz. They support data transmission conforming to OMS and DSMR. The meter time can be set when operating in conformance with DSMR. The maximum range is 400 meters.

### NOTICE



Insert the module in slot 2.

The module is available in 2 different versions:

WZU-RF      Module with internal antenna

WZU-RF-EXT    Module with SMA, connection for external antenna

### Data output conforming to OMS

The following data is available:

- Current energy
- Current volume
- Current power
- Current flow rate
- Current temperatures heat and cold side
- Error (manufacturer-specific)
- Current time stamp (type I)

Other data telegrams are available on request (e.g. special telegrams for mobile data acquisition).

### Power supply

The RF module is powered via the meter. A D-cell is required if the meter is battery powered.

### LoRa module

#### WZU-LR / WZU-LR-EXT



### Function description

The Long Range Wide Area Network (LoRaWAN) is a low-power network protocol. The LoRa alliance establishes the LoRaWAN specification; it is freely available and uses a special modulation technology.

The LoRaWAN module sends the meter data over a LoRaWAN wireless network to an application server (control unit) that the end customer can access. The meter data is transmitted immediately after start. The mobile 'Elvaco OTC APP' from Elvaco can configure the module.

Message type 'Standard' for the LoRa telegram includes the following data points:

- Energy
- Volume
- Power
- Flow rate
- Flow temperature
- Return temperature
- Serial number
- Error flag

At a transmission interval of 60 minutes, a battery life of 11 years can be achieved; at a transmission interval of 160 minutes, up to 16 years at good transmission quality.

### NOTICE



Insert the module in slot 2.

## NB-IoT module WZU-NB-IoT-G2

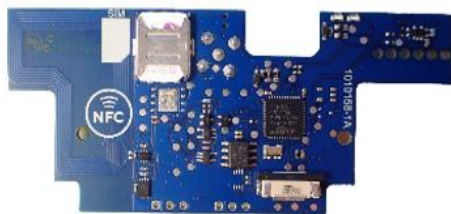

### Function description

The NB-IoT module sends the meter data over a NB-IoT network to an application server (control unit) that the end customer can access. The meter data is transmitted immediately after start. The mobile 'Elvaco OTC APP' from Elvaco can configure the module.

The NB-IoT telegram has the following data points:

- Energy (kWh)
- Volume(m<sup>3</sup>)
- Power (kW)
- Flow (m<sup>3</sup>/h)
- Flow temperature (°C).
- Return temperature (°C)
- Serial number
- Error flag
- Data and time of meter reading



The module is displayed as 'MB G4'. The module is suitable for UH50.. meters as of firmware ≥5.15.

---



Meters equipped with the NB-IoT module have optional antennas (WZU-ANT-WALL-MCX, WZU-ANT-MAG-MCX) and a battery (WZU-NB-IoT-BAT). A second battery(to the left of the battery compartment) is required (WZU-BC+GUM) if the meter is fully battery-operated. The module and meters can also be powered by just one power supply (24 V or 110/230 V).

---

**GPRS module  
WZU-GPRS**

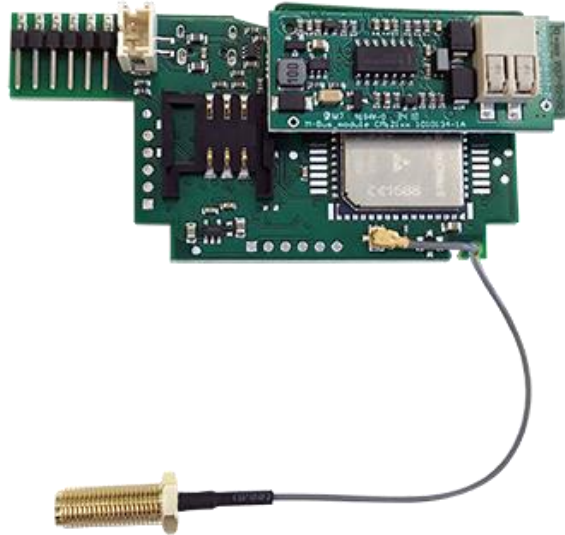

**Function description**

The module (WZU-GPRS) is a GSM/GPRS module with M-bus master. The module reads the values of the meter that support the M-bus protocol and stores the data. It is supplied complete with an external antenna.

**Properties**

- Reading and storing measured values of the heat/cooling energy meter
- Reading and storing measured values of any metering device conforming to the M-bus standard protocol
- Collection of measured values per e-mail, FTP, http, SMS transparent GSM or TCP
- Configurable report templates for manufacturer-specific reports on values, about the system, etc.
- Configurable per SMS, http, or Telenet
- Updating applications, firmware and resources via GPRS remote control

***NOTICE***



Insert the module in slot 2.

**M-bus**

The module has a built-in M-bus master, capable of reading up to another 8 M-bus meters. If the bus is overloaded, communication problems with the connected slaves occur. All connected M-bus devices (slaves) must have a unique M-bus secondary address.

**Power supply**

The module (WZU-GPRS) is supplied complete with the required power supply module (rated voltage AC 100...240 V or AC/DC 24 V).

## Communication protocols

- E-mail via SMTP with authentication mode HELO, EHLO
- Passive FTP mode with authentication and change of remote directory
- HTTP POST and GET
- GSM data transparent M-bus @ 300 and 2'400 baud and GSM data console TCP  
Transparent M-bus @300 and 2'400 baud and TCP console
- SMS for configuration
- Internet time synchronization with NTP or daytime protocol

## Tariff control

The following options are available for tariff control.



The summation of energy and volume in the standard registers is performed independently of the tariff situation!

---

### Threshold value tariff (tariffs T2, 3, 4, 5, 6)

Tariff registers 1, 2 and 3 can be controlled via up to 3 threshold values.

Either energy or volume can be added up in the tariff registers. The threshold values can be derived from the flow rate (tariff T2), power (tariff T3), temperature cold side (tariff T4), the flow temperature heat side (tariff T5), or the temperature differential (tariff T6).

#### Supplied energy / adjusted energy (tariff T7)

In tariff register 1, the energy calculated from the temperature heat side is totaled (and not from the temperature differential).

The Adjusted Energy function (as of FW 5.24) adds the energy in tariff register 1 that is calculated from the reference temperature and the temperature on the warm side.

#### Returned energy (tariff T8)

In tariff register 1, the energy calculated from the temperature cold side is totaled (and not from the temperature differential).

#### Heat/cooling energy meter (tariff T9)

In tariff register 1, the measured cooling energy is totaled; in tariff register 2, the measured heat energy. In both cases, a threshold can be defined via the temperature heat side (cold threshold, heat threshold).

Heat threshold exceeded and temperature difference  $> +0.2$  K

=> The heat quantity is acquired

Cold threshold is breached and temperature differential  $< -0.2$  K

=> Cooling energy is acquired



It is also measured in the event of negative temperature differentials.

---

#### Tariff control via time switch (tariff T10)

For tariff control, one switch-off time and one switch-on time per day can be defined. At the switch-on time, the energy or volume is totaled in tariff register 1 and ended at the switch-off time accordingly.

#### Tariff control via M-bus (tariff T11)

In tariff registers 1, 2 and 3, either energy or volume can be totaled. With the relevant M-bus command, one of the 3 tariffs can be activated or all tariffs can be deactivated.

Surcharge quantity tariff by means of return temperature (tariff T12)

The energy is totaled based on the temperature cold side in tariff registers 1 or 2.

The totaled energy is calculated from the temperature differential cold side and a defined return threshold (and not from the temperature differential).

Return threshold exceeded: T1 is totaled.

Return threshold breached: T2 is totaled.

Display of tariff situation on the LCD

The current tariff state is displayed in the user loop together with the energy or the volume in user LOOP 0.

No tariff state is displayed for tariffs T7 and T8.

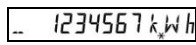
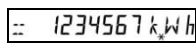
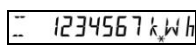
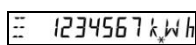

For tariffs T2, T3, T4, T5, T6, T10, T11, and T12

	No tariff register active
	Tariff register 1 active
	Tariff register 2 active
	Tariff register 3 active

For tariff T9 (cooling energy/heat meter)

	No tariff register active
	Tariff register 1 active
	Tariff register 2 active

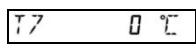
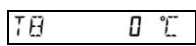
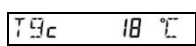
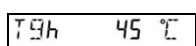
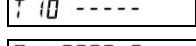
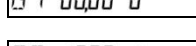
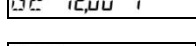
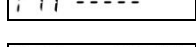
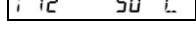

The type of tariff and the associated parameters are displayed in service loop 4.

	For T2, T3, T4, T5, and T6
	At 2-second intervals with threshold value 1/2/3
	For T7
	For T8
	For T9
	At 2-second intervals
	
	For T10
	Switching times at 2-second intervals
	For T11
	For T12

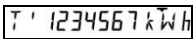
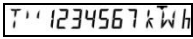
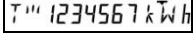
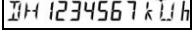
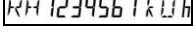

The contents of the tariff registers is displayed in the user loop after the energy.

For tariffs T2, T3, T4, T5, T6, T10, T11, and T12

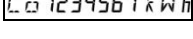
	Tariff register 1
	Tariff register 2
	Tariff register 3 (not for T12)
	For tariff T7
	For tariff T8
	For tariff T9
	

### Log functions

In the internal logbook, measurement relevant events (errors, states, actions) are stored in chronological order with the time of occurrence. The acquired events are predefined. Logbook data cannot be deleted.

Each event is stored in a separate 4-level shift register; the overflows are transferred to a 25-level circulating buffer. So that at least the last 4 times can be traced for each event.

In a monthly register, the error states are stored for the current month and the past 18 months (without time stamp).

Serial no.	Description
1	F0 = Air in measuring tube
2	F1 = Interruption hot side temperature sensor
3	F2 = Interruption cold side temperature sensor
4	F3 = Error temperature electronics
5	F5 = Short circuit hot side temperature sensor
6	F6 = Short circuit cold side temperature sensor
7	F8 = Sensor error >8 hours
8	F9 = ASIC error
9	Above max. temperature in the flow measuring section
10	Below min. temperature in the flow measuring section
11	Max. flow rate qs exceeded
12	Soiling prewarning
13	Mains voltage off
14	CRC error occurred
15	Adjustment values parameterized
16	F7 (EEPROM) prewarning
17	Reset made

Serial no.	Description
18	Date/time of day parameterized
19	Yearly set day parameterized
20	Monthly set day parameterized
21	Master reset performed
22	All times deleted
23	Error time was deleted
24	Maximum was deleted

The service software configures and reads out the data via the optical interface.

### Data logger

The data logger (optional) permits archiving of data that the user can select from a predefined set of values. The data logger contains 4 archives to which 8 channels can be assigned. The data can be assigned to any of the channels. The service software is used for the configuration.

Archive	Time base	Storage depth	Averaging time for maximum
Hourly archive	1 hour	45 days	1 hour
Daily archive	1 day	65 days	1 hour
Monthly archive	1 month	15 months	1 hour
Yearly archive	1 year	15 years	1 hour/24 hours

\*) For measuring periods of less than 1 hour, the highest value from the maximum values as calculated within 1 hour applies

The data is recorded with the values and time stamps. The service software configures and reads out the data via the optical interface.



---

Data transmission is in a manufacturer-specific format.

---

	Value set for data to be recorded
<b>Meter readings at the end of the period for...</b>	Energy Tariff register 1, 2, 3 Volume Operating time *) Fault duration *) Pulse input 1 Pulse input 2 *) Depending on configuration: Hours or days
<b>Instantaneous values at the end of the period for...</b>	Power Flow rate Temperature heat side Temperature cold side Temperature difference Indication of errors
<b>Maximum for...</b>	Power Flow rate Temperature heat side Temperature cold side Temperature difference

## Type summary

The <b>Ultrasonic heat and cooling energy meters UH50..</b> listed below are equipped as follows:	
Mounting location	In return
Rated pressure	PN 16 (PS16) /PN 25 (PS25)
Protection (o EN 60529) <ul style="list-style-type: none"> <li>Heat meter</li> <li>Combined heating/cooling energy meter</li> </ul>	Flow measuring section / Processor: IP54 Flow measuring section: IP65 / Processor: IP54 Flow measuring section: IP68 upon request
Length of control cable	1.5 m/3 m
Sensor mounting	Return sensor integrated in the flow measuring section Return sensor integrated in the flow measuring section Installing the return sensor in the measuring tube as an option
Sensing type	Pt500, DS M10x1, length 27.5 mm Pt500, DS M10x1 mm, length 38 mm Pt500, Ø 5.2 mm, length 45 mm Pt500, Ø 6 mm, length 100 mm Pt500, Ø 6 mm, length 150 mm
Temperature sensor cable length	1.5 m/5 m

Power supply	Without power supply; different types of power supply available
Communication	Without communication; different types of modules available
Display	kWh/MWh

### Heat meter

Options	Order number	Type
<b>0.6 m<sup>3</sup>/h</b> continuous flow, mounting length 110 mm, connecting thread G 3/4", PN 16, control cable length 1.5 m, Pt500, DS M10x1 mm, sensor length 27.5 mm, cable length 1.5 m, return sensor integrated in the flow measuring section, energy unit display kWh	S55561-F112	UH50-A05-00
<b>1.5 m<sup>3</sup>/h</b> continuous flow, mounting length 110 mm, connecting thread G 3/4", PN 16, control cable length 1.5 m, Pt500, DS M10x1 mm, sensor length 27.5 mm, cable length 1.5 m, return sensor integrated in the flow measuring section, energy unit display kWh	S55561-F113	UH50-A21-00
<b>1.5 m<sup>3</sup>/h</b> continuous flow, mounting length 190 mm, connecting thread G 1", PN 6, control cable length 1.5 m, Pt500, DS M10x1 mm, sensor length 27.5 mm, cable length 1.5 m, return sensor integrated in the flow measuring section, energy unit display kWh	S55561-F180	UH50-A23-00
<b>2.5 m<sup>3</sup>/h</b> continuous flow, mounting length 130 mm, connecting thread G 1", PN 16, control cable length 1.5 m, Pt500, DS M10x1 mm, sensor length 27.5 mm, cable length 1.5 m, return sensor integrated in the flow measuring section, energy unit display in kWh	S55561-F114	UH50-A36-00
<b>2.5 m<sup>3</sup>/h</b> continuous flow, mounting length 190 mm, connecting thread G 1", PN 16, control cable length 1.5 m, Pt500, DS M10x1 mm, sensor length 27.5 mm, cable length 1.5 m, return sensor integrated in the flow measuring section, energy unit display in kWh	S55561-F181	UH50-A38-00
<b>3.5 m<sup>3</sup>/h</b> continuous flow, mounting length 260 mm, connecting thread G 1 1/4", PN 6, control cable length 1.5 m, Pt500, DS M10x1 mm, sensor length 38 mm, cable length 1.5 m, return sensor integrated in the flow measuring section, energy unit display in kWh	S55561-F115	UH50-A45-00

<b>6 m<sup>3</sup>/h</b> continuous flow, mounting length 260 mm, connecting thread G 1¼", PN 16, control cable length 1.5 m, Pt500, DS M10x1 mm, sensor length 38 mm, cable length 1.5 m, return sensor integrated in the flow measuring section, energy unit display in kWh	S55561-F116	UH50-A50-00
<b>10 m<sup>3</sup>/h</b> continuous flow, mounting length 300 mm, flanged DN 40, PN 25, control cable length 1.5 m, Pt500, Ø 6 mm, sensor length 100 mm, cable length 5 m, return sensor not integrated in the flow measuring section, energy unit display in kWh	S55561-F117	UH50-A61-00
<b>15 m<sup>3</sup>/h</b> continuous flow, mounting length 270 mm, flanged DN 50, PN 25, control cable length 3 m, Pt500, Ø 6 mm, sensor length 100 mm, cable length 5 m, return sensor not integrated in the flow measuring section, energy unit display in MWh	S55561-F118	UH50-A65-00
<b>25 m<sup>3</sup>/h</b> continuous flow, mounting length 300 mm, flanged DN 65, PN 25, control cable length 3 m, Pt500, Ø 6 mm, sensor length 100 mm, cable length 5 m, return sensor not integrated in the flow measuring section, energy unit display in MWh	S55561-F119	UH50-A70-00
<b>40 m<sup>3</sup>/h</b> continuous flow, mounting length 300 mm, flanged DN 80, PN 25, control cable length 3 m, Pt500, Ø 6 mm, sensor length 150 mm, cable length 5 m, return sensor not integrated in the flow measuring section, energy unit display in MWh	S55561-F120	UH50-A74-00
<b>60 m<sup>3</sup>/h</b> continuous flow, mounting length 360 mm, flanged DN 100, PN 25, control cable length 3 m, Pt500, Ø 6 mm, sensor length 150 mm, cable length 5 m, return sensor not integrated in the flow measuring section, energy unit display in MWh	S55561-F121	UH50-A83-00

#### Heat/cooling energy meter

Options	Order number	Type
<b>0.6 m<sup>3</sup>/h</b> continuous flow, mounting length 110 mm, connecting thread G ¾", PN 16, control cable length 1.5 m, Pt500, DS M10x1 mm, sensor length 27.5 mm, cable length 1.5 m, return sensor integrated in the flow measuring section, energy unit display kWh	S55561-F122	UH50-C05-00
<b>0.6 m<sup>3</sup>/h</b> continuous flow, mounting length 110 mm, connecting thread G ¾", PN 25, control cable length 1.5 m, Pt500, DS M10x1 mm, sensor length 27.5 mm, cable length 1.5 m, return sensor installation in the measuring tube, energy unit display in kWh	S55561-F252	UH50-C06-00

<b>1.5 m<sup>3</sup>/h</b> continuous flow, mounting length 110 mm, connecting thread G ¾", PN 16, control cable length 1.5 m, Pt500, DS M10x1 mm, sensor length 27.5 mm, cable length 1.5 m, return sensor integrated in the flow measuring section, energy unit display kWh	S55561-F123	UH50-C21-00
<b>1.5 m<sup>3</sup>/h</b> continuous flow, mounting length 110 mm, connecting thread G ¾", PN 25, control cable length 1.5 m, Pt500, DS M10x1 mm, sensor length 27.5 mm, cable length 1.5 m, return sensor installation in measuring tube optional, energy unit display kWh	S55561-F253	UH50-C22-00
<b>1.5 m<sup>3</sup>/h</b> continuous flow, mounting length 190 mm, connecting thread G 1", PN 25, control cable length 1.5 m, Pt500, DS M10x1 mm, sensor length 27.5 mm, cable length 1.5 m, return sensor installation in the measuring tube optional, energy unit display kWh	S55561-F254	UH50-C25-00
<b>2.5 m<sup>3</sup>/h</b> continuous flow, mounting length 130 mm, connecting thread G 1", PN 16, control cable length 1.5 m, Pt500, DS M10x1 mm, sensor length 27.5 mm, cable length 1.5 m, return sensor integrated in the flow measuring section, energy unit display in kWh	S55561-F124	UH50-C36-00
<b>2.5 m<sup>3</sup>/h</b> continuous flow, mounting length 130 mm, connecting thread G 1", PN 25, control cable length 1.5 m, Pt500, DS M10x1 mm, sensor length 27.5 mm, cable length 1.5 m, return sensor installation in the measuring tube optional, energy unit display kWh	S55561-F255	UH50-C37-00
<b>2.5 m<sup>3</sup>/h</b> continuous flow, mounting length 190 mm, connecting thread G 1", PN 25, control cable length 1.5 m, Pt500, DS M10x1 mm, sensor length 27.5 mm, cable length 1.5 m, return sensor installation in the measuring tube optional, energy unit display kWh	S55561-F256	UH50-C40-00
<b>3.5 m<sup>3</sup>/h</b> continuous flow, mounting length 260 mm, connecting thread G 1¼", PN 16, control cable length 1.5 m, Pt500, DS M10x1 mm, sensor length 38 mm, cable length 1.5 m, return sensor integrated in the flow measuring section, energy unit display in kWh	S55561-F125	UH50-C45-00
<b>3.5 m<sup>3</sup>/h</b> continuous flow, mounting length 260 mm, connecting thread G 1¼", PN 25, control cable length 1.5 m, Pt500, DS M10x1 mm, sensor length 38 mm, cable length 2.5 m, return sensor installation in the measuring tube optional, energy unit display kWh	S55561-F257	UH50-C47-00

<b>6 m<sup>3</sup>/h</b> continuous flow, mounting length 260 mm, connecting thread G 1¼", PN 16, control cable length 1.5 m, Pt500, DS M10x1 mm, sensor length 38 mm, cable length 1.5 m, return sensor integrated in the flow measuring section, energy unit display in kWh	S55561-F126	UH50-C50-00
<b>6 m<sup>3</sup>/h</b> continuous flow, mounting length 260 mm, flanged DN 25, PN 25, control cable length 1.5 m, Pt500, Ø 6 mm, sensor length 45 mm, cable length 1.5 m, return sensor not integrated in the flow measuring section, energy unit display in kWh	S55561-F258	UH50-C52-00
<b>10 m<sup>3</sup>/h</b> continuous flow, mounting length 300 mm, connecting thread G 2", PN 16, control cable length 1.5 m, Pt500, Ø 6 mm, sensor length 100 mm, cable length 2 m, return sensor not integrated in the flow measuring section, energy unit display in kWh	S55561-F259	UH50-C60-00
<b>10 m<sup>3</sup>/h</b> continuous flow, mounting length 300 mm, flanged DN 40, PN 25, control cable length 1.5 m, Pt500, Ø 6 mm, sensor length 100 mm, cable length 5 m, return sensor not integrated in the flow measuring section, energy unit display in kWh	S55561-F127	UH50-C61-00
<b>15 m<sup>3</sup>/h</b> continuous flow, mounting length 270 mm, flanged DN 50, PN 25, control cable length 3 m, Pt500, Ø 6 mm, sensor length 100 mm, cable length 5 m, return sensor not integrated in the flow measuring section, energy unit display in MWh	S55561-F128	UH50-C65-00
<b>25 m<sup>3</sup>/h</b> continuous flow, mounting length 300 mm, flanged DN 65, PN 25, control cable length 3 m, Pt500, Ø 6 mm, sensor length 100 mm, cable length 5 m, return sensor not integrated in the flow measuring section, energy unit display in MWh	S55561-F129	UH50-C70-00
<b>40 m<sup>3</sup>/h</b> continuous flow, mounting length 300 mm, flanged DN 80, PN 25, control cable length 3 m, Pt500, Ø 6 mm, sensor length 150 mm, cable length 5 m, return sensor not integrated in the flow measuring section, energy unit display in MWh	S55561-F130	UH50-C74-00
<b>60 m<sup>3</sup>/h</b> continuous flow, mounting length 360 mm, flanged DN 100, PN 25, control cable length 3 m, Pt500, Ø 6 mm, sensor length 150 mm, cable length 5 m, return sensor not integrated in the flow measuring section, energy unit display in MWh	S55561-F131	UH50-C83-00



Other types available on request.

**Power supply modules for UH50..**

<b>Component (optional)</b>	<b>Order number</b>	<b>Type</b>
Power pack AC 110/230 V, cable length 1.5 m	S55563-F154	WZU-AC110/230-15
Power pack AC 110/230 V, cable length 5 m	LYU:WZU-AC110/230-50	WZU-AC110/230-50
Power pack AC/DC 24 V, with terminals	S55563-F156	WZU-ACDC24-50
Standard battery (2 AA), for 6 years with holder, applications: Standard pulses, Standard M-bus readout (every 15 minutes)	S55563-F114	WZU-BA+GUM
Universal battery (D-cell) for 6 or 16 years Applications for 16 years: Standard pulses, standard M-bus readout (15 min.) Application for 6 years: All communication modules	S55563-F113	WZU-BDS



Other types available on request.

Communication modules WZU-GPRS and WZU-GPRS-ANT are supplied complete with power supply. In that case, none of the above-mentioned power supply modules need be ordered.

**Communication modules for UH50..**

<b>Stock no. (optional)</b>	<b>Order number</b>	<b>Type</b>
Pulse module with 2 channels to output standard or "definable" pulses	S55563-F107	WZU-P2
M-bus module for heat and heat/cooling energy meters, generation 4, recommended as of firmware 5.15 As of heat and heat/cooling energy meters firmware 5.17 and module firmware 4.10	S55563-F110	WZU-MB G4
M-bus module with 2 pulse inputs For Generation 4 heat and heat/cooling energy meters as of firmware 5.15 As of heat and heat/cooling energy meters firmware 5.17 and module firmware 4.10	S55563-F108	WZU-MI
BACnet module RS-485 per ASHRAE 135 and ISO 16484-5 for meters as of firmware 5.15	LYU:WZU-485E-BAC	WZU-485E-BAC
Modbus module RS-485 per Modbus RTU protocol for meters as of firmware 5.15	LYU:WZU-485E-MOD	WZU-485E-MOD
RF module 868 MHz per EN 13737-4 only as of meters firmware 5.17	LYU:WZU-RF	WZU-RF



RF module 868 MHz per EN 13737-4 only as of meters firmware 5.17 with external antenna	LYU:WZU-RF-EXT	WZU-RF-EXT
GPRS module with external antenna (magnetic attachment) and with power pack AC 110...230 V as of meter firmware 5.15	LYU:WZU-GPRS	WZU-GPRS
GPRS module with external antenna (for screw mounting) and with power pack AC 110...230 V as of meter firmware 5.15	LYU:WZU-GPRS-ANT	WZU-GPRS-ANT
LoRa module	LYU: WZU-LR	WZU-LR
LoRa module with external antenna	LYU:WZU-LR-EXT	WZU-LR-EXT
NB-IoT module As of meter firmware 5.15 with external antenna	LYU:WZU-NB-IoT-G2	WZU-NB-IoT-G2
Battery with compartment for NB-IoT module At a daily transmission interval: 11 years	LYU:WZU-NB-IoT-BAT	WZU-NB-IoT-BAT
Analog module	LYU:WZU-AM	WZU-AM
Power pack for analog module	LYU:WZU-NE24	WZU-NE24
Antenna with magnetic base	LYU:WZU-ANT-MAG	WZU-ANT-MAG
Wall-mounted antenna	LYU:WZU-ANT-WALL	WZU-ANT-WALL
Antenna for NB-IoT module magnetic base, band 8/20	LYU:WZU-ANT-MAG-MC	WZU-ANT-MAG-MCX
Antenna to wall mount NB-IoT module, band 8/20	LYU:WZU-ANT-WALL-M	WZU-ANT-WALL-MCX



Other types available on request.

#### Temperature sensors for UH50..

Component	Order number	Type
Pt500, DS M10x1 mm, sensor length 27.5 mm, cable length 1.5 m	LYU:WZU5-2815	WZU5-2815
Pt500, DS M10x1 mm, sensor length 27.5 mm, cable length 2.5 m	LYU:WZU5-2825	WZU5-2825
Pt500, DS M10x1 mm, sensor length 38 mm, cable length 1.5 m	LYU:WZU5-3815	WZU5-3815
Pt500, DS M10x1 mm, sensor length 38 mm, cable length 2.5 m	LYU:WZU5-3825	WZU5-3825
Pt500, PS Ø 5.2x45 mm, cable length 1.5 m	LYU:WZU5-4515	WZU5-4515
Pt500, PS Ø 5.2x45 mm, cable length 5 m	LYU:WZU5-4550	WZU5-4550

Pt500, PL Ø 6x100 mm, cable length 2 m	LYU:WZU5-1020	WZU5-1020
Pt500, PL Ø 6x100 mm, cable length 5 m	LYU:WZU5-1050	WZU5-1050
Pt500, PL Ø 6x150 mm, cable length 2 m	LYU:WZU5-1520	WZU5-1520
Pt500, PL Ø 6x150 mm, cable length 5 m	LYU:WZU5-1550	WZU5-1550
Pt500, universal temperature sensor pair Ø 6 mm, cable length 3 m	LYU:WZU5-U630	WZU5-U630
Pt500, universal temperature sensor pair Ø 6 mm, cable length 5 m	LYU:WZU5-U650	WZU5-U650
Pt500, universal temperature sensor pair Ø 6 mm, cable length 10 m	LYU:WZU5-U6100	WZU5-U6100

## Mounting accessories for UH50..

### Fittings

Stock no. (optional)	Order number	Type
Mounting set for L = 110 mm, consisting of: 2x ball valve Rp ¾" with union nut G ¾" (WZT-K34-34) 1x ball valve Rp ¾" with connection for the direct installation of temperature sensors M10 x 1 (WZT-K34) 1x spacer 110 mm (WZM-G110) 2x flat seals	LYU:WZT-MS110	WZT-MS110
Mounting set for L = 130 mm consisting of: 2x ball valve Rp 1" with union nut G 1" (WZT-K1-1) 1x ball valve Rp 1" with connection for the direct installation of temperature sensors M10 x 1 (WZT-K1) 1x spacer 130 mm (WZM-G130) 2x flat seals	LYU:WZT-MS130	WZT-MS130
Mounting kit G ¾", consisting of: 2 x fittings G ¾" x R ½" 2 x union nut G ¾" 2 x gasket G ¾"	S55563-F124	WZM-E34
Mounting kit 1", consisting of: 2 x fittings G 1" x R ¾" 2 x union nut G 1" 2 x gasket G 1"	S55563-F123	WZM-E1
Mounting kit 1¼", consisting of: 2 x fittings G 1¼" x R 1" 2x union nut G 1¼" 2x gasket G 1¼"	S55563-F125	WZM-E54

Mounting kit 2", consisting of: 2 x fittings G 2" x R 1½" 2 x union nut G 2" 2 x gasket G 2"	LYU:WZM-E2.1	WZM-E2.1
Adapter piece 110 mm G ¾" to 130 mm G ¾": 1 x extension G ¾ B" to G ¾ B" 1 x gasket G ¾"	LYU:WZM-V130	WZM-V130
Adapter piece 110 mm G ¾" to 130 mm G 1": 2 x extension G ¾ B" to G 1 B" 2 x gasket G ¾" 2 x gasket G 1"	LYU:WZM-V130.G1	WZM-V130.G1
Adapter piece 110 mm G ¾" to 165 mm G ¾": 1 x extension G ¾ B" to G ¾ B" 1 x gasket G ¾"	LYU:WZM-VE165	WZM-VE165
Adapter piece 110 mm G ¾" to 190 mm G 1": 2 x extension G ¾ B" to G 1 B" 2 x gasket G ¾" 2 x gasket G 1"	LYU:WZM-V190	WZM-V190

### Spacers and gaskets

Stock no. (optional)	Order number	Type
Spacer G ¾", length 110 mm, incl. 2 gaskets	LYU:WZM-G110	WZM-G110
Spacer G 1", length 130 mm, incl. 2 gaskets	LYU:WZM-G130	WZM-G130
Spacer G 1", length 190 mm, incl. 2 gaskets	LYU:WZM-G190	WZM-G190
Spacer G 1¼", length 260 mm, incl. 2 gaskets	LYU:WZM-G260	WZM-G260
Spacer G 2", length 300 mm, incl. 2 gaskets	LYU: WZM-G300.1	WZM-G300.1
Spacer DN 20, length 190 mm, PN 16, incl. 2 flat gaskets	LYU:WZM-F190	WZM-F190
Spacer DN 25, length 260 mm PN 16, incl. 2 flat gaskets	LYU:WZM-F260	WZM-F260
Spacer DN 50, length 270 mm PN 16, incl. 2 flat gaskets	LYU:WZM-F270	WZM-F270

Spacer DN 40, length 300 mm PN 16, incl. 2 flat gaskets	LYU:WZM-F300	WZM-F300
Spacer DN 65, length 300 mm, PN 16, incl. 2 flat gaskets	LYU:WZM-F300.65	WZM-F300.65
Spacer DN 80, length 300 mm PN 16, incl. 2 flat gaskets	LYU:WZM-F300.80	WZM-F300.80
Spacer DN 100, length 360 mm PN 25, incl. 2 flat gaskets	LYU:WZM-F360.10- 25	WZM-F360.100-25
Sealing disk G ¾", for threaded connection R ½"	LYU:9060944002	9060944002
Sealing disk G 1", for threaded connection R ¾"	LYU:9060944003	9060944003
Sealing disk G 1¼", for threaded connection R 1"	LYU:9060944004	9060944004
Sealing disk for DN 40, q <sub>p</sub> 10 m <sup>3</sup> /h	LYU:9060944024	9060944024
Sealing disk for DN 50, q <sub>p</sub> 15 m <sup>3</sup> /h	LYU:9060944025	9060944025
Sealing disk for DN 65, q <sub>p</sub> 25 m <sup>3</sup> /h	LYU:9060944026	9060944026
Sealing disk for DN 80, q <sub>p</sub> 40 m <sup>3</sup> /h	LYU:9060944027	9060944027
Sealing disk for DN 100, q <sub>p</sub> 60 m <sup>3</sup> /h	LYU:9060944028	9060944028

## Accessories

Accessories	Order number	Type
Welding sleeve with threaded hole for temperature sensor DS M10x1 mm	S55563-F121	WZT-G10
Welding sleeve G ½", 45° to pipe axis, with threaded hole G ½"	S55563-F122	WZT-G12
Welding sleeve G ½", 90° to pipe axis, with threaded hole G ½"	LYU:WZT-GLG	WZT-GLG
Ball valve Rp ½" for mounting the sensor DS M10x1 mm, length 28 mm, max. water temperature 130 °C, PN 25	S55563-F104	WZT-K12
Ball valve Rp ¾" for mounting the sensor DS M10x1 mm, length 28 mm, max. water temperature 130 °C, PN 25	S55563-F120	WZT-K34
Ball valve Rp 1" for mounting the sensor DS M10x1 mm, length 28 mm, max. water temperature 130 °C, PN 25	S55563-F119	WZT-K1
Ball valve Rp 1¼" with connection for the direct installation of temperature sensors DS M10x1 mm, length 38 mm	LYU: WZT-K54	WZT-K54

Ball valve Rp 1½" with connection for the direct installation of temperature sensors DS M10x1 mm, length 38 mm	LYU:WZT-K112	WZT-K112
Ball valve Rp 2" with connection for the direct installation of temperature sensors DS M10x1 mm, length 38 mm	LYU: WZT-K2	WZT-K2
Ball valve Rp ½" with union nut G ¾"	LYU: WZT-K12-34	WZT-K12-34
Ball valve Rp ¾" with union nut G ¾"	LYU:WZT-K34-34	WZT-K34-34
Ball valve Rp ¾" with union nut G 1"	LYU: WZT-K34-1	WZT-K34-1
Ball valve Rp 1" with union nut G 1"	LYU:WZT-K1-1	WZT-K1-1
Ball valve Rp 1¼" with union nut G 1¼"	LYU: WZT-K54-54	WZT-K54-54
Ball valve Rp 2" with union nut G 2"	LYU: WZT-K2-2	WZT-K2-2
Adapter for ball valve to install sensor DS M10x1 mm, length 38 mm	LYU:WZT-KA	WZT-KA
Adapter G ⅝ B" with threaded hole for sensor DS M10x1 mm, incl. gasket G ⅝" made of copper	LYU:WZT-A38	WZT-A38
Adapter G ½ B" with threaded hole for sensor DS M10x1 mm, incl. gasket G ½" made of copper	S55563-F116	WZT-A12
Adapter G ¾ B" with threaded hole for sensor DS M10x1 mm, incl. gasket G ¾" made of copper	LYU:WZT-A34	WZT-A34
Protection pocket G ½ B" made of stainless steel, with threaded hole G ¼", mounting length 100 mm, for temperature sensor Ø 6.0 x 100 mm or universal sensor Ø 6.0 mm, including G ½" copper gasket	S55563-F117	WZT-S100
Protection pocket G ½ B" made of stainless steel, with threaded hole G ¼", mounting length 150 mm, for temperature sensor Ø 6.0 x 150 mm or universal sensor Ø 6.0 mm, including G ½" copper gasket	S55563-F118	WZT-S150
Protection pocket G ½ B" made of stainless steel, with locking screw, mounting length 210 mm, for universal sensor Ø 6.0 mm, including G ½" copper gasket	LYU:WZT-S210	WZT-S210
Protection pocket G ½ B" made of brass, Ø 5.2x35 mm for temperature sensor Ø 5.2x45 mm, including G ½" copper gasket.	S55563-F103	WZT-M35
Protection pocket G ½ B" made of brass, Ø 5.2x50 mm, for temperature sensor Ø 5.2x45 mm, including G ½" copper gasket	LYU:WZT-M50	WZT-M50

Protection pocket G ½ B" made of stainless steel, Ø 5,2 x 50 mm, for temperature sensor Ø 5,2 x 45 mm, including G ½" copper gasket	LYU:WZT-S43V	WZT-S43V
Adapter set for universal sensor Ø 6.0 M12 x 1.5", brass adapter fittings	LYU:WZT-FAM12	WZT-FAM12
Adapter set for universal sensor Ø 6,0 2 x 1/4" plastic adapter fittings	LYU:WZT-FAG14	WZT-FAG14
Mounting set for temperature sensor Ø 5.2x45 mm, consisting of: - 1 sensor fitting M10x1 mm, brass - 2 O-rings - 1 grooved pin - 1 Sensor mounting aid	LYU:WZT-FA	WZT-FA
Mounting set for temperature sensor Ø 5.2x45 mm, consisting of: - 1 sensor fitting M10x1 mm, plastic - 2 O-rings - 1 Sensor mounting aid	LYU:9956230	9956230
Mounting set G ½ B" with threaded hole G ¼" for direct mounting of long sensors	LYU:WZT-A100	WZT-A100
Sealing disk for temperature sensor M10x1 mm, Ø 8,6/5,3x1 mm	LYU:9060944001	9060944001
Sealing disc ½" made of copper	LYU:9060948	9060948
Service key to start calibration mode	LYU:9089885	9089885
Mounting plate for top hat rail	LYU:WZU-MH	WZU-MH
Mounting plate for wall mounting	LYU:WZU-WA	WZU-WA
Wall-mount plate (standard)	LYU:WZU-WH	WZU-WH
Self-lock seal with sealing wire	LYU:9956186001	9956186001

### Programming accessories

Accessories	Order number	Type
Optical read head with USB interface for PC	LYU:WZR-OP-USB	WZR-OP-USB
Readout and configuration software UltraAssist	Available on request	-

### Readout and parameterization software

For further information about the UltraAssist Light read and parameterization software see chapter "Functions".

### Ordering

When ordering, please provide the quantity, description, product no. and stock no.

Designation	Ordering number	Type
Ultrasonic heat meter	S55561-F114	UH50-A36-00

### Scope of delivery

Operating and installation instructions in multiple languages are included with the ultrasonic heat and heat/cooling meters.

### Languages

The instructions are supplied in 18 languages:

Bulgarian, Chinese, Croatian, Czech, Dutch, English, French, German, Greek, Hungarian, Italian, Norwegian, Polish, Russian, Slovakian, Slovenian, Spanish, and Turkish.

## Installation

**Flow measuring section**

The mounting position is optional, the mounting location (return) must be in accordance with the type of meter used.

**NOTICE**

Always install the flow measuring section in the return on types UH50-A., UH50-C., and UH50-G...

Settling paths are not required, neither upstream of nor downstream from the meter. Thoroughly flush the plant prior to installing the meter.

Install the flow measuring section between 2 shutoff valves with the arrow pointing in the direction of flow. The sensors must be mounted in the same water circuit as the flow measuring section (observe mixing). Do not separate, shorten, or extend the lines.

Connect the individual wires according to the wiring diagram printed on the meter.

The sensors can be fitted in T-pieces or ball valves, or can be immersed, either directly or in pockets (observe all national regulations).

**NOTICE**

In Germany, the temperature sensors must be installed submerged for meters to  $q_p$  6 and to PN16.

- Immersion sleeves are only needed in the case of higher stress levels.

In any case, the end of the sensors' probe must extend to at least the pipe center. Temperature sensors and fittings must be sealed to prevent tampering. Overpressure must prevent cavitation across the entire measuring range, that is, at least 1 bar with  $q_p$  and approximately 3 bar with  $q_s$  (at 80 °C).

Only authorized personnel are allowed to remove and replace calibration seals when carrying out service work.

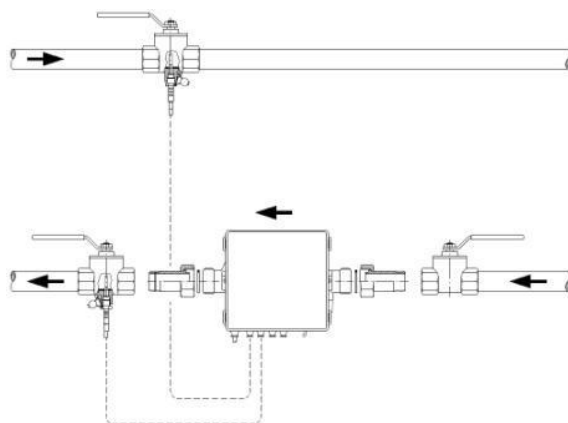
**Ball valve**

Example of mounting with a ball valve (recommended up to  $q_p$  6)



**Welded sleeve with protection pocket**

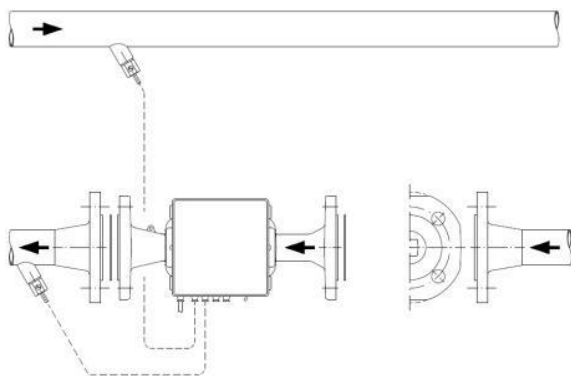

Example of mounting with protection pockets (recommended above  $q_p$  10)

**Required position for the cooling energy meter**

To avoid the formation of condensation on cooling energy or combined heat/cooling energy meters, make sure the black cover on the measuring tube points to the side or downward. Install the protection pockets so that the temperature sensor is horizontal or vertical, pointing down. Mount the processor unit away from the flow measuring section (e.g. on the wall). Make sure that condensation cannot run along the connected lines, entering the processor unit (forming a loop downward).

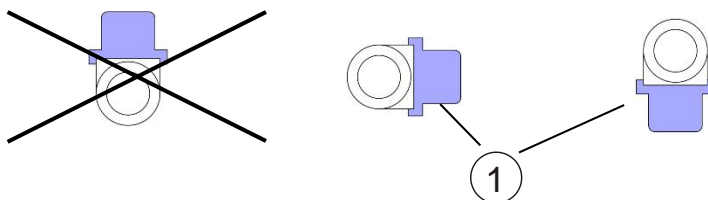

1 Transducer cover

Permissible mounting position when metering cooling energy

**Processor unit**

The ambient temperature of the processor unit cannot exceed 55 °C. Avoid direct sunlight. During installation, ensure the no water can penetrate the processor unit during operation. To fit the processor unit to the wall, remove it from the flow measuring section and undo the screws of the adapter plate. The latter must then be secured to the wall so that the processor unit can be replaced on the adapter plate, snapping into place.

<b>NOTICE</b>	
<b>!</b>	<p>On models with removable control wiring, you can disconnect and reconnect the wiring during installation.</p> <ul style="list-style-type: none"> <li>● Connect only paired parts (volume measuring section, processor unit) when reconnecting.</li> <li>● Note the correct pin assignment.</li> <li>● Do not extend nor shorten the control wiring.</li> </ul>

## Maintenance

---

The meters are maintenance-free.  
Observe all national calibration regulations.

## Disposal

---



This symbol or any other national label indicate that the product, its packaging, and, where applicable, any batteries may not be disposed of as domestic waste. Delete all personal data and dispose of the item(s) at separate collection and recycling facilities in accordance with local and national legislation.  
For additional details, refer to [www.siemens.com/bt/disposal](http://www.siemens.com/bt/disposal).

## Warranty service

The application-related technical data is only guaranteed together with the products mentioned in this data sheet. Siemens rejects any and all warranties in the event that third-party products are used.

**Processor unit**

Functional data	
Measuring range (national approvals may differ)	0...180 °C
Range of temperature differential $\Delta\Theta$	3...120 K
Temperature response threshold	0.2 K.
Thermal coefficient	Shifting compensated
Temperature-measuring error without sensor	$(0.5 + \Delta\Theta_{\min.}/\Delta\Theta)$ %, max. 1.5% at $\Delta\Theta = 3$ K

Temperature sensors	
Sensing element	Pt500 per EN 60751
Temperature range	0...150 °C (up to 45 mm mounting length) 0...180 °C (from 100 mm mounting length)

Optical interface	
Basic design	Similar to EN 62056-21
Protocol	Per EN 62056-21

Cable length	
Control cable	1.5, 3, and 5 m
Sensor types	DS M10x1 mm, sensor length 27.5 mm DS M10x1 mm, sensor length 38 mm Pocket short $\varnothing$ 5.2x45 mm PL $\varnothing$ 6 universal Pocket long $\varnothing$ 6x100 mm Pocket long $\varnothing$ 6x150 mm

**Flow measuring section**

Functional data	
Temperature range (national approvals may differ)	5...130 °C
Recommended temperature range	10...130 °C 5...50 °C
<ul style="list-style-type: none"> <li>● Heating</li> <li>● Cooling</li> </ul>	

Functional data	
Rated pressure	1.6 MPa (PN 16; PS 16)/2.5 MPa (PN 25; PS 25)
Mounting position	Any
Mounting location	Return

Continuous flow $q_p$	Installation length	Connection	Maximum flow $q_s$	Minimum flow $q_i$	Response threshold (variable)	Pressure loss at $q_p$	Kv flow rate at $\Delta p$ 1 bar	Kv flow rate at $\Delta p$ 100 mbar	Weight
m <sup>3</sup> /h	mm	G/DN	m <sup>3</sup> /h	l/h	l/h	mbar	m <sup>3</sup> /h	m <sup>3</sup> /h	kg
0.6	110	G 3/4	1.2	6	2.4	150	1.5	0.5	1
0.6	190	G 1	1.2	6	2.4	150	1.5	0.5	1.5
0.6	190	DN20	1.2	6	2.4	150	1.5	0.5	3
1.5	110	G 3/4	3	15	6	150	3.9	1.2	1
1.5	130	G 1	3	15	6	160	3.8	1.2	1.5
1.5	190	G 1	3	15	6	160	3.8	1.2	1.5
1.5	190	DN20	3	15	6	160	3.8	1.2	3
2.5	130	G 1	5	25	10	200	5.6	1.8	1.5
2.5	190	G 1	5	25	10	210	5.3	1.7	1.5
2.5	190	DN20	5	25	10	210	5.3	1.7	3
3.5	260	G 1 1/4	7	35	14	55	15	4.7	3
3.5	260	DN25	7	35	14	55	15	4.7	5
6	150	G 1 1/4	12	60	24	190	14	4.4	3
6	260	G 1 1/4	12	60	24	140	16	5.1	3
6	260	DN25	12	60	24	140	16	5.1	5
10	200	G 2	20	100	40	130	28	8.8	2.6
10	300	G 2	20	100	40	110	30	9.5	4
10	300	DN40	20	100	40	130	28	8.8	7
15	200	DN50	30	150	60	95	49	15.4	5
15	270	DN50	30	150	60	110	45	14.3	8
25	300	DN65	50	250	100	105	77	24.4	11
40	300	DN80	80	400	160	160	100	31.6	13
60	360	DN100	120	600	240	115	177	56.0	22
150	500	DN150	300	1500	600	120	433	136.9	50 *)

\*) Measuring insert 4 kg

Tolerance in the event of pressure drop: +/- 5%

## Power supply optional

<b>Standard battery WZU-BA+GUM</b>	
Standard battery	
<ul style="list-style-type: none"> <li>• Battery type</li> <li>• Battery voltage</li> <li>• Battery life</li> </ul>	2 AA lithium batteries (Li-SOCI2) 3.6 V Max. 6 years

<b>Universal battery WZU-BDS</b>	
Universal battery	
<ul style="list-style-type: none"> <li>• Battery type</li> <li>• Battery voltage</li> <li>• Battery life</li> </ul>	1 D-cell lithium battery (Li-SOCI2) 3.6 V 6...16 years (depending on configuration)

<b>Battery for NB-IoT module WZU-NB-IoT-BAT</b>	
Universal battery	
<ul style="list-style-type: none"> <li>• Battery type</li> <li>• Battery voltage</li> <li>• Battery life</li> </ul>	1 C cell lithium battery (Li-MnO2) 3 V Transmission interval daily: 11 years

<b>Power pack AC 110/230 V WZU-AC110/230-15 *) WZU-AC110/230-50 *)</b>	
Power pack AC 110/230 V	
<ul style="list-style-type: none"> <li>• Protection class</li> <li>• Voltage range</li> <li>• Frequency</li> <li>• Maximum power consumption</li> <li>• Overvoltage category II as per EN 61010-1</li> <li>• Length of connecting cable</li> <li>• External fusing of supply line</li> <li>• Backup time in the event of power failure</li> </ul>	II AC 100 to 240 V 50/60 Hz 2.5 VA CAT 2  1.5 m/5 m Automatic cutout 6 A ≥4 h

\*) The power pack has two outputs. One output powers the meter; the other an optional plug-in GPRS or NB-IoT module.

**Power pack AC/DC 24 V  
WZU-ACDC24-50**

Power pack AC/DC 24 V	
<ul style="list-style-type: none"> <li>● Protection class</li> <li>● Power supply</li> <li>● Frequency</li> <li>● Maximum power consumption</li> <li>● Terminals</li> <li>● For connecting line</li> <li>● Backup time in the event of power failure</li> </ul>	<p>III (SELV) AC 12...35 V or DC 12...50 V 50/60 Hz or DC 2.5 W 2x 1.0 mm<sup>2</sup> Ø 5...6 mm &gt;30 min.</p>

**Communication**

**Pulse module  
WZU-P2**

Pulse outputs	
<ul style="list-style-type: none"> <li>● Number of outputs per module</li> <li>● Standard pulses <ul style="list-style-type: none"> <li>– Pulse value</li> <li>– Pulse length</li> <li>– Period duration</li> </ul> </li> <li>● Pulse for operating states <ul style="list-style-type: none"> <li>– Pulse duration for "Ready"</li> <li>– Pulse duration for "Fault"</li> <li>– Period duration</li> </ul> </li> <li>● Fast pulses <ul style="list-style-type: none"> <li>– Pulse length</li> <li>– Max. pulse frequency</li> </ul> </li> <li>● Fast pulses <ul style="list-style-type: none"> <li>– Pulse length</li> <li>– Max. pulse frequency</li> </ul> </li> <li>● Type</li> <li>● Voltage</li> <li>● Current</li> <li>● Classification per EN 1434-2 <ul style="list-style-type: none"> <li>– Voltage drop</li> </ul> </li> <li>● Classification per EN 1434-2 <ul style="list-style-type: none"> <li>– Voltage drop</li> </ul> </li> </ul>	<p>2 For energy, volume and tariff register 1 kWh, 10 kWh, 1 MJ, 10 MJ, 100 MJ, 0.1 m<sup>3</sup>, 1 m<sup>3</sup> per pulse 100 ms conducting &gt;200 ms 0.1...0.25 ms conducting Constantly non-conducting 500 ms If 1 pulse module is fitted 2...100 ms in increments of 1 ms 33 Hz If 2 pulse modules are fitted 5...100 ms in increments of 5 ms 33 Hz Open collector Max. DC 30 V Max. 30 mA OB Approx. 1.3 V at 20 mA OC Approx. 0.3 V at 0.1 mA 500 V<sub>eff</sub> against ground</p>
Dielectric strength	

**M-bus module****WZU-MB G4****WZU-MI**

M-bus slave interface	As per EN 1434-3 and EN 13757-2 /-3
• Voltage	Max. DC 50 V
• Power consumption	1 M-bus load (1.5 mA)
• Addressing	Primary or secondary
• Baud rate	300, 1200, 2400, 4800, 9600 baud
• Polarity	Any
• Galvanic isolation	
– From meter	Yes
– From pulse inputs	No

## M-bus module WZU-MI

### Part of pulse input

Pulse inputs	As per EN 1434-2, class IB
● Number of inputs	2
● Module battery	
– Battery type	1 BR2477A (LiCF)
– Battery voltage	3 V
– Battery life	Operating: Up to 5 years Storage time: +1 year If M-bus voltage is fed to the module for at least 90% of the operating time, battery life is extended to 10 years
● Pulse duration (Low)	≥50 ms
● Pulse duration (High)	≥50 ms
● Frequency	Max. 10 Hz
● Polarity	Yes
● Galvanic isolation	Yes
– From meter	No
– From M-bus inputs	0.01 to 10,000,00 liters per pulse
● Pulse value	In increments of 0,01 liter per pulse In m3, 7 digits, without or with 1 decimal place, depending on parameter setting
● Display	Approx. 3.3 V
● Output voltage	Approx. 1 MΩ
● Internal resistance	Approx. 3 μA
● Source current	
● Pulse input closed (Low)	<0.2 V
– Switching threshold low	<50 kΩ
– Resistance	
● Pulse input open (High)	Collector not fully activated
– Switching threshold high	≥6 MΩ
– Resistance	10 m
● Max. cable length	



**BACnet module****WZU-485E-BAC**

<ul style="list-style-type: none"> <li>• Communication protocol</li> <li>• Supported services</li> <li>• BACnet™ address range</li> <li>• Transmission rate</li> <li>• Data update</li> <li>• HW network connection</li> <li>• RS-485 terminating resistance</li> <li>• Alternating current</li> <li>• Direct current</li> <li>• Power consumption</li> <li>• Recommended fusing</li> <li>• Galvanic isolation <ul style="list-style-type: none"> <li>– From meter:</li> <li>– From the RS-485 network</li> </ul> </li> </ul>	<p>BACnet MS/TP (RS-485) per ASHRAE 135 and ISO 16484-5</p> <p>BACnet Application Specific Controller (B-ASC), BACnet Master Mode</p> <p>1 ... 127</p> <p>9600 to 76800 bps</p> <p>Default: 38400 bps</p> <p>Standby: 60 min.</p> <p>Operating: After each query, max. every 10 seconds</p> <p>Protected against short overload</p> <p>Use external resistance (<math>\Rightarrow</math> 120 <math>\Omega</math>)</p> <p>AC 16 ... 28 V</p> <p>DC 10 ... 32 V</p> <p>&lt; 50 mA (typically &lt; 20 mA at 24 V)</p> <p>100 mA, slow</p> <p>Yes</p> <p>No</p>
---	---

**Modbus module****WZU-485E-MOD**

<ul style="list-style-type: none"> <li>• Communication protocol</li> <li>• ModBus® address range</li> <li>• Transmission rate</li> <li>• Modbus parity</li> <li>• Data update</li> <li>• HW network connection</li> <li>• RS-485 terminating resistance</li> <li>• Alternating current</li> <li>• Direct current</li> <li>• Power consumption</li> <li>• Recommended fusing</li> <li>• Galvanic isolation <ul style="list-style-type: none"> <li>– From meter:</li> <li>– From the RS-485 network</li> </ul> </li> </ul>	<p>Modbus RTU5</p> <p>0 ... 247</p> <p>2400 to 19200 bps</p> <p>Default: 9600 bps</p> <p>Even</p> <p>Standby: 60 min.</p> <p>Operating: After each query, max. every 10 seconds</p> <p>Protected against short overload</p> <p>Use external resistance (<math>\Rightarrow</math> 120 <math>\Omega</math>)</p> <p>AC 16 ... 28 V</p> <p>DC 10 ... 32 V</p> <p>&lt; 50 mA (typically &lt; 20 mA at 24 V)</p> <p>100 mA, slow</p> <p>Yes</p> <p>No</p>
--	---

<b>Analog module WZU-AM</b>	
Analog outputs <ul style="list-style-type: none"> <li>• Number of outputs</li> <li>• Output variable</li> <li>• Max. load at current output</li> <li>• Max. load at voltage output</li> <li>• Precision</li> <li>• Max. cable length</li> <li>• Cable cross-section</li> <li>• Outputs short-circuit proof</li> <li>• Galvanic isolation from meter</li> </ul>	2 Current or voltage configurable 300 Ω 2 kΩ ≤ ±} 1% of parameterized max. value 100 m Max. 1.5 mm <sup>2</sup> Yes Yes
External power supply <ul style="list-style-type: none"> <li>• Voltage range</li> <li>• Power consumption</li> <li>• Power consumption</li> </ul>	AC 12...30 V or DC 12...42 V Max. 170 mA at 12 V Max. 2 VA
External fuse (not enclosed) <ul style="list-style-type: none"> <li>• &lt; AC/DC 24 V</li> <li>• ≥ AC/DC 24 V</li> <li>• Breaking capacity</li> </ul>	As per EN 60127-2 200 mA, slow 100 mA, slow 35 A (L)

<b>RF module, 868 MHz WZU-RF, WZU-RF-EXT</b>	
RF interface <ul style="list-style-type: none"> <li>• Transmission frequency</li> <li>• Transmitter power</li> <li>• Receive frequency</li> <li>• Antenna</li> <li>• RF protocol</li> <li>• Range</li> </ul>	As per EN 13757-2/ -4 868.95 MHz 3.16...25 mW 868.30 MHz Integrated on WZU-RF, external on WZU-RF-EXT OMS-/DSMR compliant data transmission Max. 400 m/typically 30 m in buildings

**RF module, 868 MHz  
WZU-LR / WZU-LR-EXT**

<ul style="list-style-type: none"> <li>● Transmission frequency</li> <li>● Transmitter power (ERP)</li> <li>● Range*)             <ul style="list-style-type: none"> <li>– Free field of view</li> <li>– In buildings</li> </ul> </li> <li>● Power supply Via meter **)             <ul style="list-style-type: none"> <li>– Power is supplied with a power supply</li> </ul> </li> <li>● Meets the standard</li> </ul> <p>*) Can differ significantly depending on the building structure. **) Replace by type D if another battery is installed. The battery life applies for standard data telegrams (content similar to P600) as well as UH50.. at the default measuring interval for flow and temperature.</p>	<p>868 MHz 25 mW (14 dBm)</p> <p>10 km 100 m</p> <p>Battery type D Transmission interval: 60 minutes, life cycle: 11 years Transmission interval: 160 minutes, life cycle: 16 years 110/230/24 V (not with Elvaco: 24 V) LoRaWAN Version 1.0 (Class A bi-directional)</p>
---	---

**Radio module  
WZU-NB-IoT-G2**

<ul style="list-style-type: none"> <li>● Band (transmission frequency)</li> <li>● Max. transmitter power (ERP)</li> <li>● Max. transmission interval</li> <li>● SIM card format</li> <li>● Antenna</li> <li>● Range*)             <ul style="list-style-type: none"> <li>– Free field of view</li> <li>– In buildings</li> </ul> </li> <li>● Power supply             <ul style="list-style-type: none"> <li>– Power is supplied with a power supply</li> <li>– Battery for NB-IoT with holder **)</li> </ul> </li> <li>● Meets the standard</li> </ul> <p>*) Can differ significantly depending on the building structure. **) The meter requires an additional battery, C cell (WZU-BC+GUM) in the left compartment.</p>	<p>3 (1800 MHz), 8 (900 MHz), 20 (800 MHz) 200 mW (23 dBm) Max. every 5 minutes '4FF' (Nano SIM) For external antennas with MCX plug</p> <p>10 km 100 m</p> <p>WZU-ACDC24-50 (with 2 outputs) WZU-AC110/230-xx (with 2 outputs)</p> <p>WZU-NB-IoT-BAT Transmission interval daily: 11 years service life 3GPP release 14 (NB2)</p>
--	--

GPRS module WZU-GPRS WZU-GPRS-ANT	
GPRS interface <ul style="list-style-type: none"> <li>• Band</li> <li>• External antenna</li>   <li>• Logs</li>   <li>• Configuration</li> <li>• Backup real-time clock</li> <li>• Max. humidity in operation               <ul style="list-style-type: none"> <li>– Power supply</li> <li>– Voltage range</li> <li>– Frequency</li> <li>– Power consumption</li> <li>– Rated consumption</li> <li>– Overvoltage category as per EN 61010-1</li> </ul> </li> </ul>	Class 12 850/900/1,800/1,900 MHz WZU-GPRS with magnetic base WZU-GPRS-ANT with screwed connection Email over SMTP Passive FTP mode HTTP POST and GET GMS data transparent M-bus TCP transparent M-bus SMS, HTTP, FTP, GSM CSD 12 h 80% r.h. Enclosed with module: AC 100...240 V -20%...+15% 50/60 Hz < 6 W < 1 W II

GPRS module WZU-GPRS M-bus master	
M-bus master interface <ul style="list-style-type: none"> <li>• Baud rate</li> <li>• Number of M-bus slaves</li> <li>• Line length</li> <li>• Mechanical design</li> </ul>	As per EN 13757 2400 and 9600 baud Max. 8 Max. 1000 2-wire connection, interchangeable

Housing type	
Degree of protection processor unit	IP54

Ambient conditions			
	Operation	Transport	Storage
	IEC/EN 60721-3-3	IEC/EN 60721-3-2	IEC/EN 60721-3-1
Climatic conditions	Class A	Class A	Class A
Temperature	+5...+55 °C-	-20...+60 °C	-20...+60 °C

Ambient conditions			
Humidity	<93 % r.h. at 25 °C (non-condensing)	<93% r.h. at 25 °C (non-condensing)	<93% r.h. at 25 °C (non-condensing)
Mechanical conditions	Class M1	Class M1	Class M1
Max. altitude	Min. 700 hPa, corresponding to max. 2,000 m above sea level		

Standards, directives and approvals	
Product standards	DIN EN 1434-x (heat/cooling energy meters)
EU conformity (CE)	CE2T5324xx *)
RCM Conformity	CE2T5372en_C1 *)

Environmental compatibility
The product environmental declaration 8000079744 *) contains data on environmentally compatible product design and assessments (RoHS compliance, materials composition, packaging, environmental benefit, disposal).

Dimensions	
(W x H x D):	
<ul style="list-style-type: none"> <li>Processor unit</li> <li>Flow measuring section</li> </ul>	143 x 136 x 42 mm See "Dimensions"

Housing material	
Cover	PC
Bottom section	PC-GF10

Housing colors	
Cover	Front crystal-clear, logo PEs plastic foil, RAL 7035 and RAL 5014
Bottom section	RAL 9002

\*) The documents can be downloaded at <http://siemens.com/bt/download>.

## Dimensions

Dimensions in mm

### Processor unit

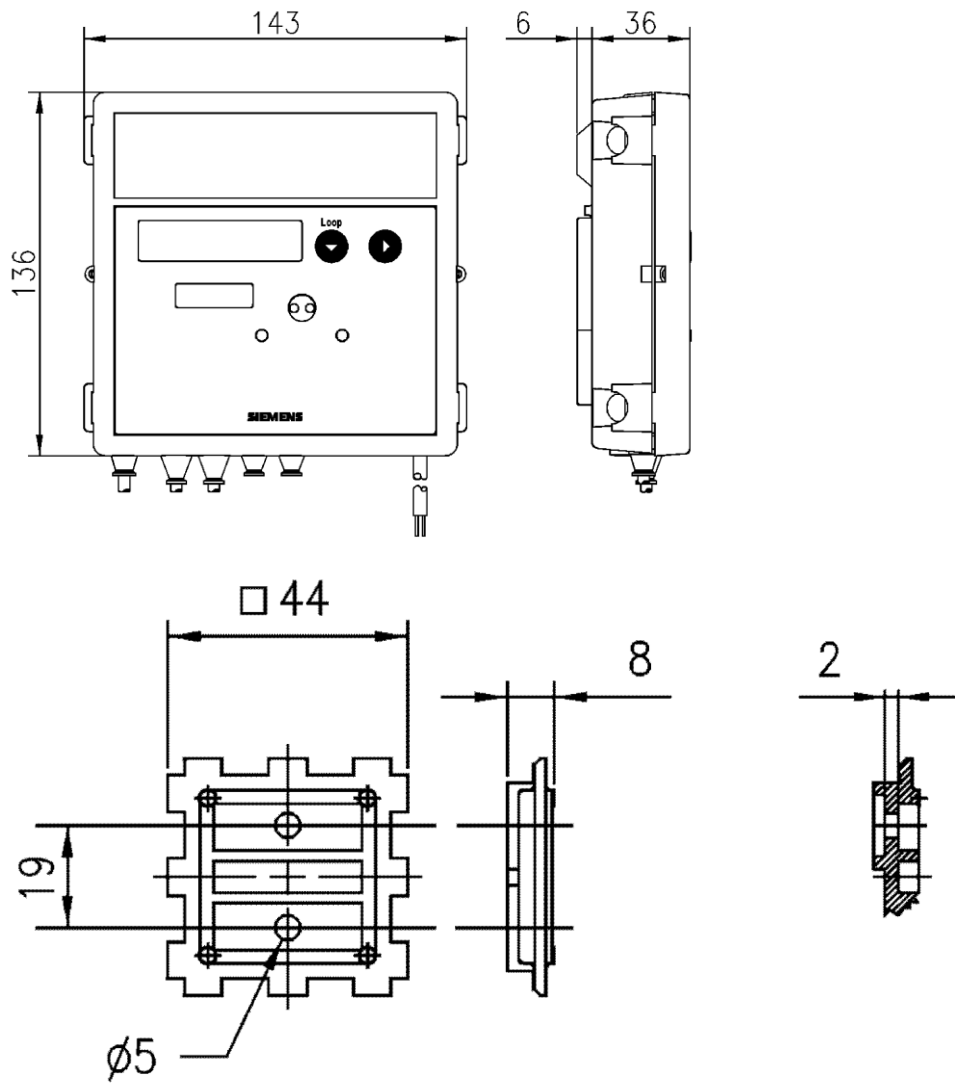

Adapter plate

Cross-sectional area

**Flow measuring section**  
**0.6...2.5 m<sup>3</sup>/h**

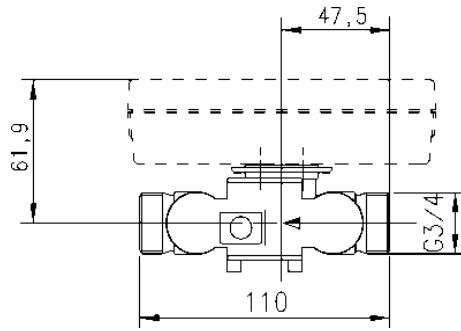

Mounting length 110 mm (threaded)

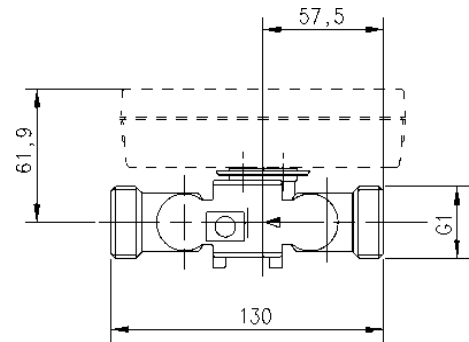

Mounting length 130 mm (threaded)

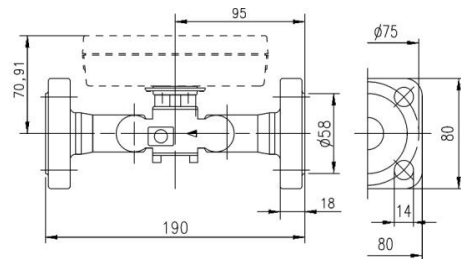

Mounting length 190 mm (flanged)

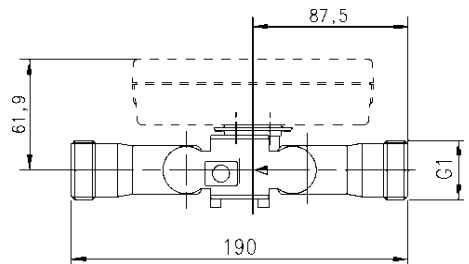

Mounting length 190 mm (threaded)

**Flow measuring section as of 3.5 m<sup>3</sup>/h**

**with threaded connection**  
 Alternative mounting options

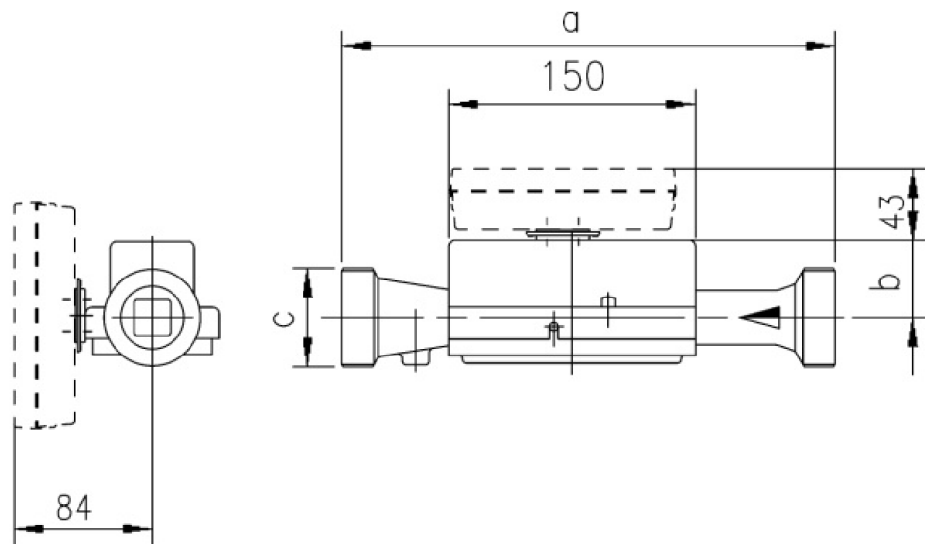

Product no.	qp m³/h	PN bar	a	b	c
UH50-x45	3.5	16	260	51	G11/4
UH50-x47		25			
UH50-x50	6	16	260	51	G11/4
UH50-x51	6	25	260	51	G11/4
UH50-x60	10	16	300	48	G2
UH50-x62	10	25	300	48	G2
UH50-x63		16			

Flow measuring section as of 3.5 m³/h

Flanged

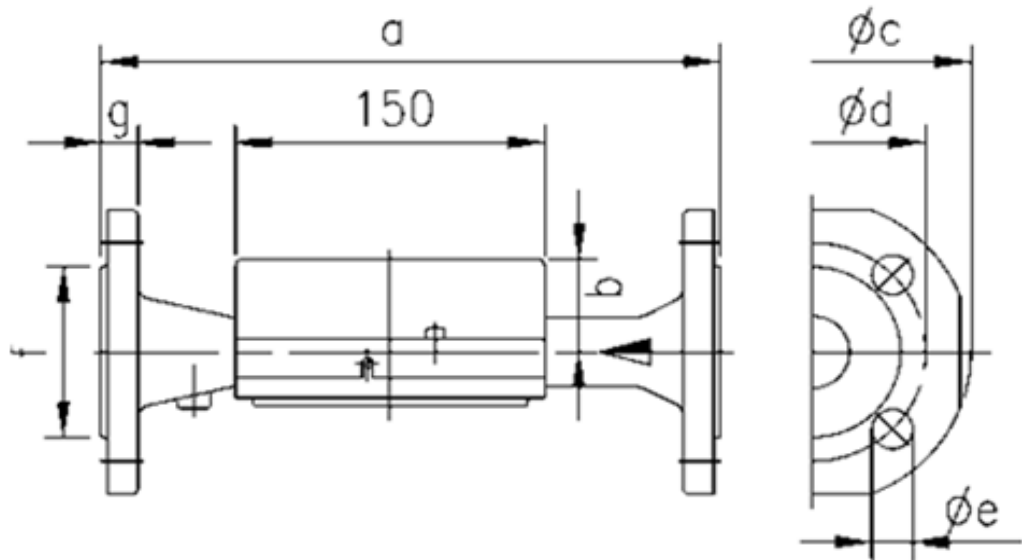

Product no.	qp m³/h	PN bar	DN	a	b	Øc	Ød	Øe	Number of holes	f	g
UH50-x46	3.5	25	25	260	51	115	85	14	4	68	18
UH50-x52	6	25	25	260	51	115	85	14	4	68	18
UH50-x61	10	25	40	300	48	150	110	18	4	88	18
UH50-x65	15	25	50	270	46	165	125	18	4	102	20
UH50-x69				200							
UH50-x70	25	25	65	300	52	185	145	18	8	122	22
UH50-x74	40	25	80	300	56	200	160	18	8	138	24
UH50-x82	60	16	100	360	68	235	180	18	8	158	24
UH50-x83	60	25	100	360	68	235	190	22	8	158	24



Large meter  $q_p$  150

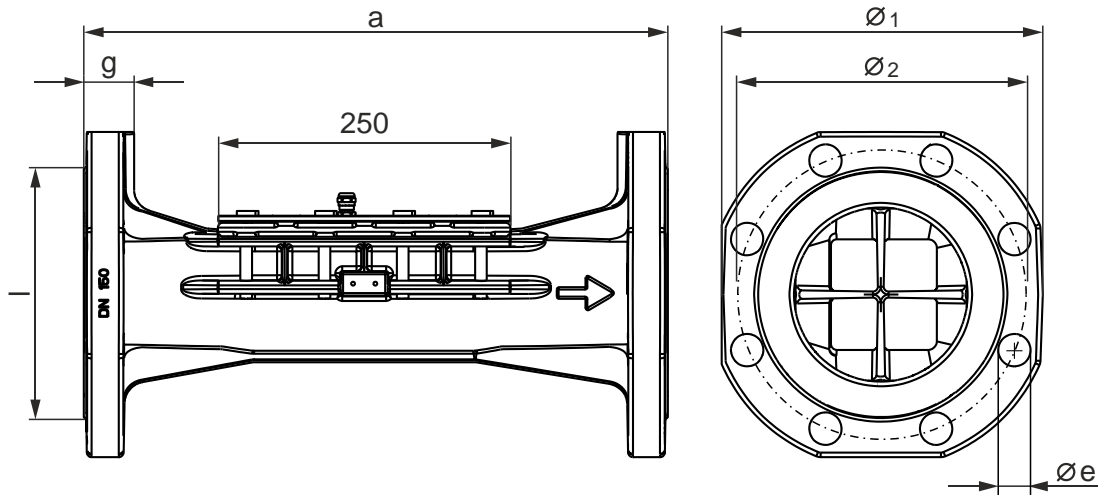

Product no.	$q_p$ m <sup>3</sup> /h	PN bar	DN	a	b	Øc	Ød	Øe	Number of holes	f	g
UH50-xA1	150	16	150	500	91	300	240	23	8	211	31
UH50-xA2	150	25	150	500	91	300	250	28	8	211	31

Issued by  
Siemens Switzerland Ltd  
Smart Infrastructure  
Global Headquarters  
Theilerstrasse 1a  
CH-6300 Zug  
+41 58 724 2424  
[www.siemens.com/buildingtechnologies](http://www.siemens.com/buildingtechnologies)

© Siemens Switzerland Ltd, 2012  
Technical specifications and availability subject to change without notice.

---

Document ID    CE2N5324en  
Edition        2022-08-12